

FAST

FESTO

**In stock products, ready to ship across
North America**

RG TECHNOLOGIES



FAST

In stock and ready to ship.

Get the products you need, when you need them—quickly and reliably. Festo FASTSM ensures next-day shipping on readily available items from our state-of-the-art Mason, Ohio facility, backed by dependable service to keep your operations running smoothly.

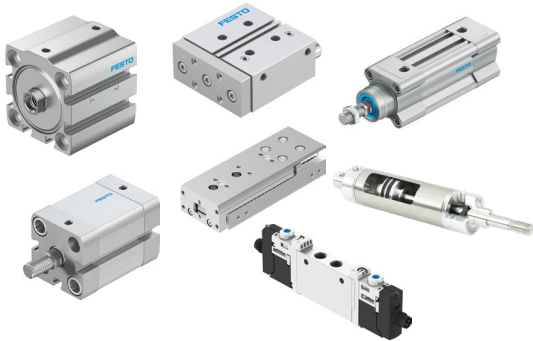

Pneumatic Automation

- Actuators and cylinders
- Cylinder switches
- Valves
- Air preparation
- Fittings and tubing

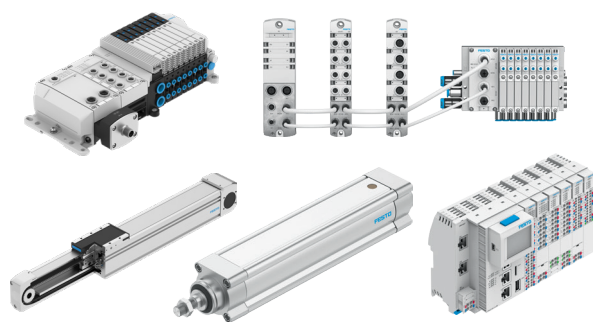

Electric Automation

- Electric actuators
- Motors and drives
- Remote I/O



Look for the stopwatch in the online shop or in Quick Search Plus to easily find products that are in stock and available for next day shipping.



Download Quick Search Plus



Online shop

Compact cylinders - ADN, to ISO 21287

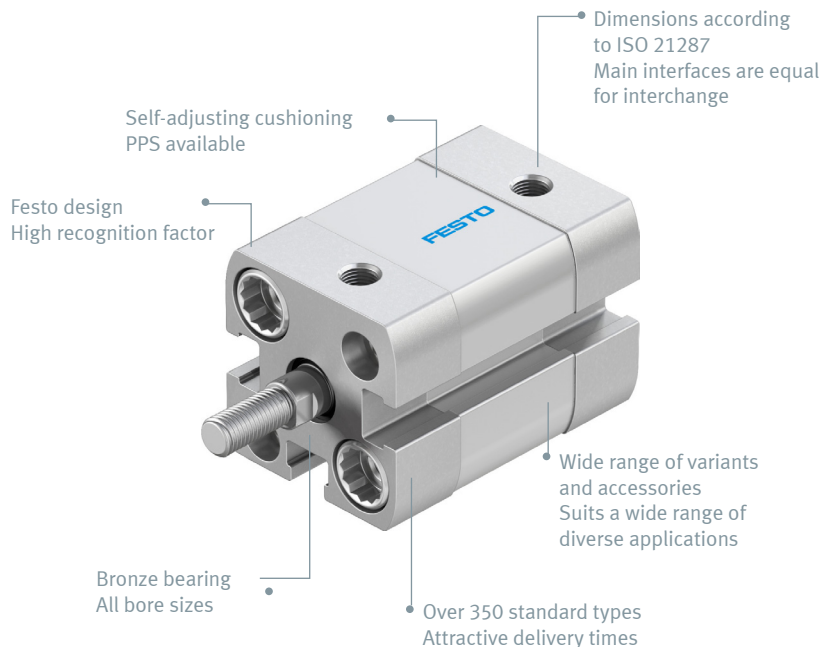

001	002	003	004	005	006
ADN					A
001	Type				
ADN	Standards-based cylinder, double-acting, based on ISO 21287				
002	Piston Ø [mm]				
---	12, 16, 20, 25, 32, 40, 50, 63, 80				
003	Stroke [mm]				
---	5, 10, 15, 20, 25, 30, 40, 50, 80				
004	Piston rod thread type				
A	Male thread				
I	Female thread				
005	Cushioning				
P	Elastic cushioning rings/plates at both ends				
006	Position sensing				
A	Via proximity switch				

Actuators and cylinders



Ordering – Basic design

003 Stroke [mm]	002 Piston Ø [mm]								
	12	16	20	25	32	40	50	63	80
	004 Piston rod with male thread – 005 Cushioning – 006 Position sensing								
A-P-A									
5	536204	536219	536234	536251	536268	536289	536310		
10	536205	536220	536235	536252	536269	536290	536311	536332	536353
15	536206	536221	536236	536253	536270	536291	536312	536333	536354
20	536207	536222	536237	536254	536271	536292	536313	536334	536355
25	536208	536223	536238	536255	536272	536293	536314	536335	536356
30	536209	536224	536239	536256	536273	536294	536315	536336	536357
35	8178327	8178762	8178859	574647	576645	8179031	8178336		
40	536210	536225	536240	536257	536274	536295	536316	536337	536358
50	8178548	536331	536241	536258	536275	536296	536317	536338	536359
60			536352	536373	536276	536297	536318	536339	536360
80					536277	536298	536319	536340	536361
004 Piston rod with female thread – 005 Cushioning – 006 Position sensing									
I-P-A									
5	536211	536226	536242	536259	536278	536299	536320		
10	536212	536227	536243	536260	536279	536300	536321	536342	536363
15	536213	536228	536244	536261	536280	536301	536322	536343	536364
20	536214	536229	536245	536262	536281	536302	536323	536344	536365
25	536215	536230	536246	536263	536282	536303	536324	536345	536366
30	536216	536231	536247	536264	536283	536304	536325	536346	536367
35		8178765	578011	608920	8179019	8179033	8178619		
40	536217	536232	536248	536265	536284	536305	536326	536347	536368
50	8178550	536341	536249	536266	536285	536306	536327	536348	536369
60			536362	536383	536286	536307	536328	536349	536370
80					536287	536308	536329	536350	536371

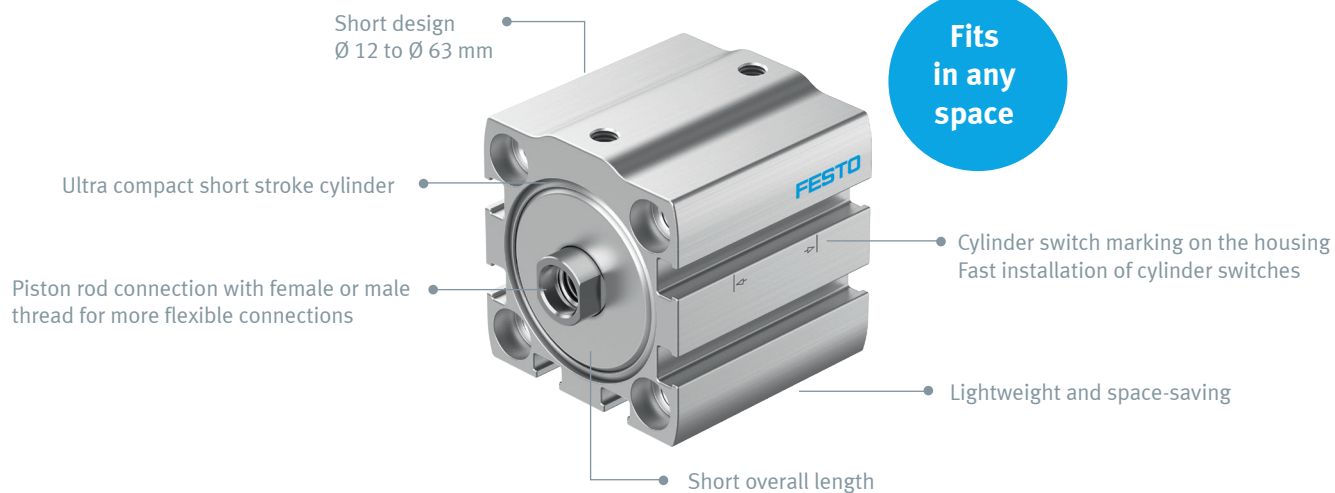

Compact cylinders - ADN-S/AEN-S

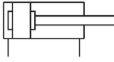

005 Piston rod thread	006 Cushioning	007 Position sensing
A: Male thread I: Female thread	-: Without P: Elastic cush. rings	-: Without A: Via proximity sensor
I 	P 	A 

Ordering – Ø 12 mm/16 mm

003 Piston Ø [mm]				ADN-S-12-...						
				004 Stroke [mm]						
005	006	007	008	5	10	15	20	25	30	35
I	P	-	-	8076407	8076419	8076417	8076415	8076413	8076411	8076409
I	P	A	-	8076406	8076418	8076416	8076414	8076412	8076410	8076408



003 Piston Ø [mm]				ADN-S-16-...						
				004 Stroke [mm]						
005	006	007	008	5	10	15	20	25	30	35
I	P	-	-	8076393	8076405	8076403	8076401	8076399	8076397	8076395
I	P	A	-	8076392	8076404	8076402	8076400	8076398	8076396	8076394



Ordering – Ø 20 ... 63 mm

003 Piston Ø [mm]				ADN-S-20-...									
				004 Stroke [mm]									
005	006	007	008	5	10	15	20	25	30	35	40	45	50
I	P	-	-	8076323	8076341	8076339	8076337	8076335	8076333	8076331	8076329	8076327	8076325
I	P	A	-	8076322	8076340	8076338	8076336	8076334	8076332	8076330	8076328	8076326	8076324

003 Piston Ø [mm]				ADN-S-25-...									
				004 Stroke [mm]									
005	006	007	008	5	10	15	20	25	30	35	40	45	50
I	P	-	-	8076343	8076361	8076359	8076357	8076355	8076353	8076351	8076349	8076347	8076345
I	P	A	-	8076342	8076360	8076358	8076356	8076354	8076352	8076350	8076348	8076346	8076344

003 Piston Ø [mm]				ADN-S-32-...									
				004 Stroke [mm]									
005	006	007	008	5	10	15	20	25	30	35	40	45	50
I	P	-	-	8076364	8076382	8076380	8076378	8076376	8076374	8076372	8076370	8076368	8076366
I	P	A	-	8076363	8076381	8076379	8076377	8076375	8076373	8076371	8076369	8076367	8076365

003 Piston Ø [mm]				ADN-S-40-...									
				004 Stroke [mm]									
005	006	007	008	5	10	15	20	25	30	35	40	45	50
I	P	A	-	5138606	5138607	5138608	5138609	5138610	5138611	5138612	5138613	5138614	5138615

003 Piston Ø [mm]				ADN-S-50-...									
				004 Stroke [mm]									
005	006	007	008	5	10	15	20	25	30	35	40	45	50
I	P	A	-	5138188	5138189	5138190	5138191	5138192	5138193	5138194	5138195	5138196	5138197

003 Piston Ø [mm]				ADN-S-63-...									
				004 Stroke [mm]									
005	006	007	008	5	10	15	20	25	30	35	40	45	50
I	P	A	-	5132663	5132664	5132665	5132666	5132667	5132668	5132669	5132670	5132671	5132672



Compact mini slide - DGST

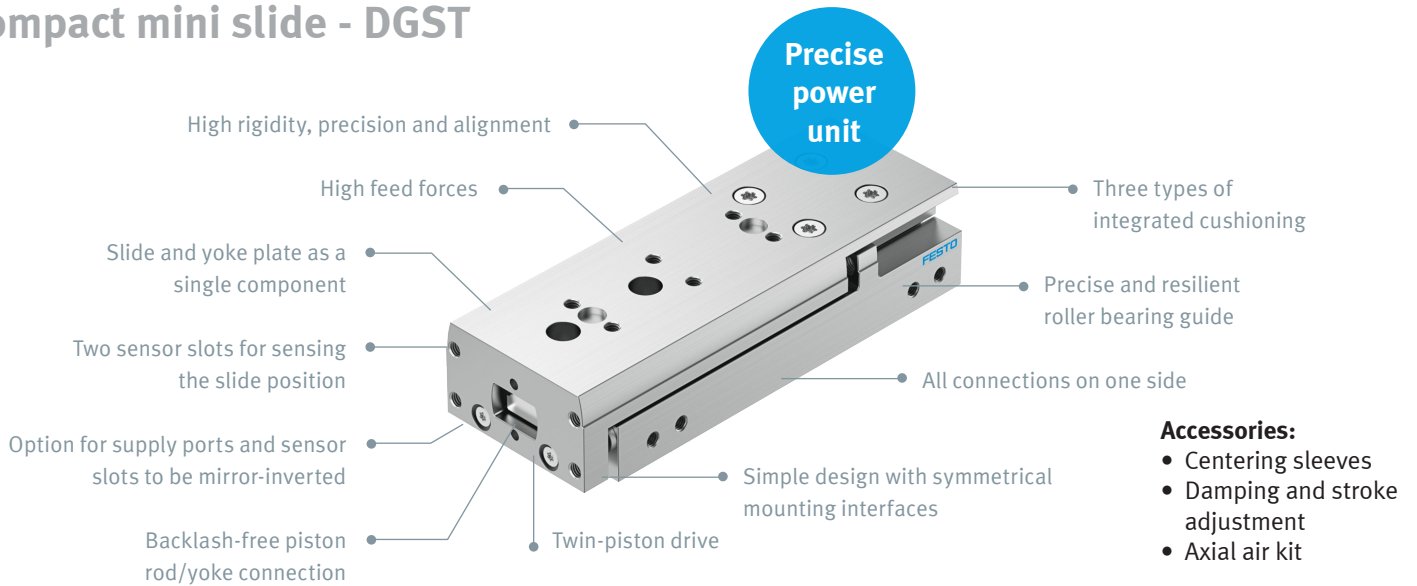

Accessories:

- Centering sleeves
- Damping and stroke adjustment
- Axial air kit

Size [mm]	6	8	10	12	16	20	25
Stroke [mm]	Cushioning E1: Elastic cushioning at both ends, no end-position adjustment						
10	8078828	8078833	8078839	8078846	8078853	8078862	8078872
20	8078829	8078834	8078840	8078847	8078854	8078863	8078873
30	8078830	8078835	8078841	8078848	8078855	8078864	8078874
40	8078831	8078836	8078842	8078849	8078856	8078865	8078875
50	8078832	8078837	8078843	8078850	8078857	8078866	8078876
80		8078838	8078844	8078851	8078858	8078867	8078877
100			8078845	8078852	8078859	8078868	8078878
125					8078860	8078869	8078879
150					8078861	8078870	8078880
200						8078871	8078881
Stroke [mm]	Cushioning P: Elastic cushioning at both ends, non-adjustable, with end-position adjustment (Ships in 3 days)						
10	8085105	8085110	8085116	8085123	8085130	8085139	8085149
20	8085106	8085111	8085117	8085124	8085131	8085140	8085150
30	8085107	8085112	8085118	8085125	8085132	8085141	8085151
40	8085108	8085113	8085119	8085126	8085133	8085142	8085152
50	8085109	8085114	8085120	8085127	8085134	8085143	8085153
80		8085115	8085121	8085128	8085135	8085144	8085154
100			8085122	8085129	8085136	8085145	8085155
125					8085137	8085146	8085156
150					8085138	8085147	8085157
200						8085148	8085158
Stroke [mm]	Cushioning Y12: Shock absorbers at both ends, self-adjusting, with end-position adjustment (Ships in 3 days)						
30	8085159	8085162	8085166	8085171	8085176	8085183	8085191
40	8085160	8085163	8085167	8085172	8085177	8085184	8085192
50	8085161	8085164	8085168	8085173	8085178	8085185	8085193
80		8085165	8085169	8085174	8085179	8085186	8085194
100			8085170	8085175	8085180	8085187	8085195
125					8085181	8085188	8085196
150					8085182	8085189	8085197
200						8085190	8085198



Guided drive - DFM

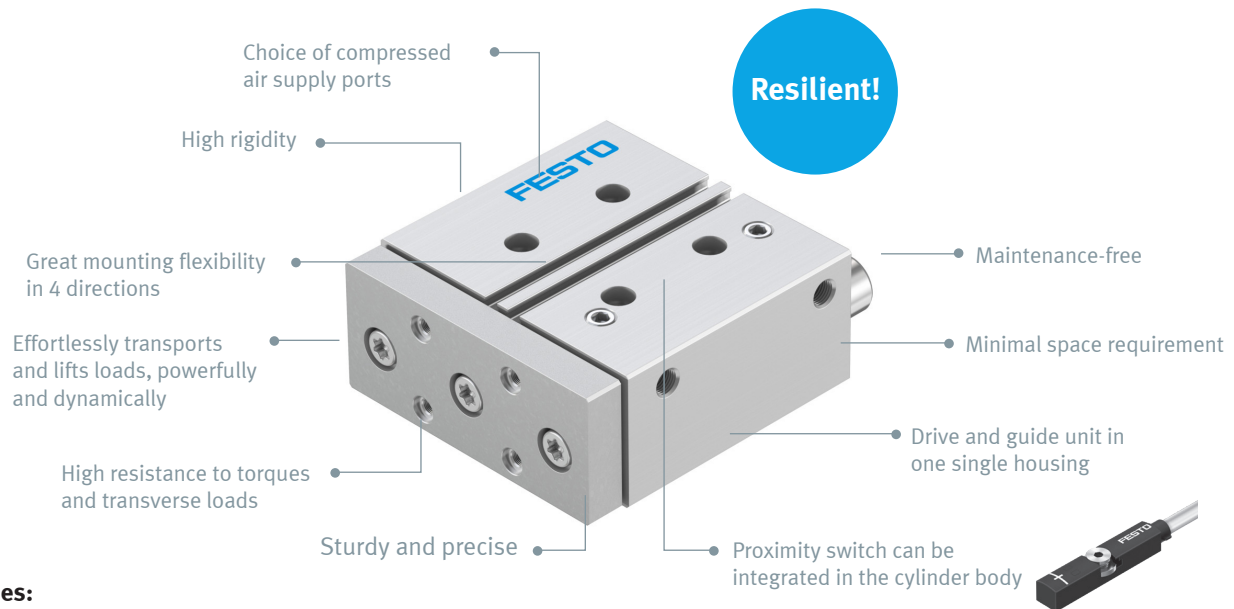

Accessories:

Centering sleeves for housing and yoke

Piston	12	16	20	25	32	40	50	63
Port	M5			G1/8			G1/4	
Stroke [mm]	Plain-bearing guide GF - high rigidity thanks to large-diameter guide rods and four plain-bearing bushes							
10	170824	170832						
20	170825	170833	170840	170847	170854			
25	170826	170834	170841	170848	170855	170864	170871	170878
30	170827	170835	170842	170849	170856			
40	170828	170836	170843	170850	170857			
50	170829	170837	170844	170851	170858	170865	170872	170879
80	170830	170838	170845	170852	170859	170866	170873	170880
100	170831	170839	170846	170853	170860	170867	170874	170881
125					170861	170868	170875	170882
160					170862	170869	170876	170883
200					170863	170870	170877	170884
Stroke [mm]	Recirculating ball bearing guide KF for applications involving torque loads							
10	170899	170907						
20	170900	170908	170915	170922	170929			
25	170901	170909	170916	170923	170930	170939	170946	170953
30	170902	170910	170917	170924	170931			
40	170903	170911	170918	170925	170932			
50	170904	170912	170919	170926	170933	170940	170947	170954
80	170905	170913	170920	170927	170934	170941	170948	170955
100	170906	170914	170921	170928	170935	170942	170949	170956
125					170936	170943	170950	170957
160					170937	170944	170951	170958
200					170938	170945	170952	170959



Interchangeable inch round air cylinder DPRA

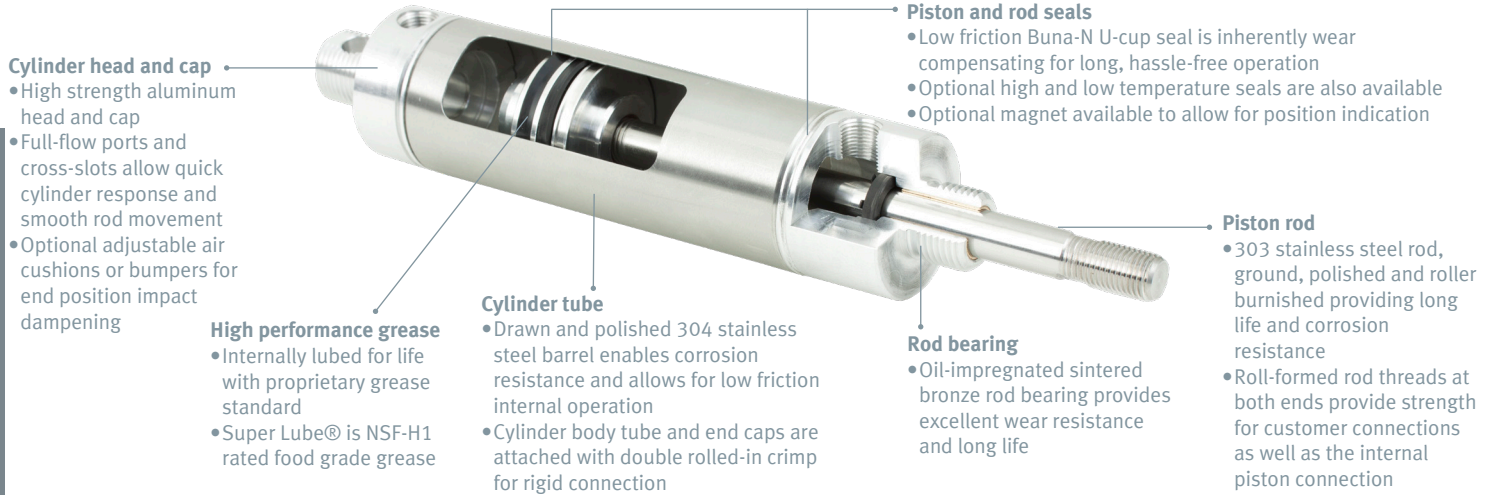

Nose mount, axial port	Stroke length [inches]	Piston diameter									
		3/4"		1 1/16"		1 1/4"		1 1/2"		2"	
	1/2"	8217823	DPRA-N-3/4"-0.5-NGP4-N	8217854	DPRA-N-1 1/16"-0.5-NGP4-N						
	1"	8217824	DPRA-N-3/4"-1-NGP4-N	8217838	DPRA-N-1 1/16"-1-NGP4-N	8217855	DPRA-N-1 1/4"-1-NGP4-N	8217879	DPRA-N-1 1/2"-1-NGP4-N	8217891	DPRA-N-2"-1-NGP4-N
	1 1/2"	8217826	DPRA-N-3/4"-1.5-NGP4-N	8217853	DPRA-N-1 1/16"-1.5-NGP4-N			8217866	DPRA-N-1 1/2"-1.5-NGP4-N		
	2"	8217827	DPRA-N-3/4"-2-NGP4-N	8217845	DPRA-N-1 1/16"-2-NGP4-N	8217856	DPRA-N-1 1/4"-2-NGP4-N	8217867	DPRA-N-1 1/2"-2-NGP4-N	8217880	DPRA-N-2"-2-NGP4-N
	3"	8217828	DPRA-N-3/4"-3-NGP4-N	8217846	DPRA-N-1 1/16"-3-NGP4-N	8217857	DPRA-N-1 1/4"-3-NGP4-N	8217868	DPRA-N-1 1/2"-3-NGP4-N	8217881	DPRA-N-2"-3-NGP4-N
	4"	8217829	DPRA-N-3/4"-4-NGP4-N	8217842	DPRA-N-1 1/16"-4-NGP4-N	8217858	DPRA-N-1 1/4"-4-NGP4-N	8217869	DPRA-N-1 1/2"-4-NGP4-N	8217882	DPRA-N-2"-4-NGP4-N
	5"			8217844	DPRA-N-1 1/16"-5-NGP4-N	8217859	DPRA-N-1 1/4"-5-NGP4-N	8217870	DPRA-N-1 1/2"-5-NGP4-N	8217883	DPRA-N-2"-5-NGP4-N
	6"							8217871	DPRA-N-1 1/2"-6-NGP4-N	8217884	DPRA-N-2"-6-NGP4-N

Rear pivot	Stroke length [inches]	Piston diameter									
		3/4"		1 1/16"		1 1/4"		1 1/2"		2"	
	1/2"	8217830	DPRA-N-3/4"-0.5-ME-N	8217839	DPRA-N-1 1/16"-0.5-ME-N						
	1"	8217825	DPRA-N-3/4"-1-ME-N	8217840	DPRA-N-1 1/16"-1-ME-N	8217860	DPRA-N-1 1/4"-1-U-N	8217872	DPRA-N-1 1/2"-1-ME-N	8217885	DPRA-N-2"-1-UB-N
	1 1/2"	8217831	DPRA-N-3/4"-1.5-ME-N	8217849	DPRA-N-1 1/16"-1.5-ME-N			8217873	DPRA-N-1 1/2"-1.5-ME-N		
	2"	8217832	DPRA-N-3/4"-2-ME-N	8217847	DPRA-N-1 1/16"-2-ME-N	8217865	DPRA-N-1 1/4"-2-U-N	8217874	DPRA-N-1 1/2"-2-ME-N	8217886	DPRA-N-2"-2-UB-N
	3"	8217833	DPRA-N-3/4"-3-ME-N	8217848	DPRA-N-1 1/16"-3-ME-N	8217861	DPRA-N-1 1/4"-3-U-N	8217875	DPRA-N-1 1/2"-3-ME-N	8217887	DPRA-N-2"-3-UB-N
	4"	8217834	DPRA-N-3/4"-4-ME-N	8217843	DPRA-N-1 1/16"-4-ME-N	8217862	DPRA-N-1 1/4"-4-U-N	8217876	DPRA-N-1 1/2"-4-ME-N	8217888	DPRA-N-2"-4-UB-N
	5"	8217835	DPRA-N-3/4"-5-ME-N	8217850	DPRA-N-1 1/16"-5-ME-N	8217863	DPRA-N-1 1/4"-5-U-N	8217877	DPRA-N-1 1/2"-5-ME-N	8217889	DPRA-N-2"-5-UB-N
	6"			8217852	DPRA-N-1 1/16"-6-ME-N	8217864	DPRA-N-1 1/4"-6-U-N	8217878	c DPRA-N-1 1/2"-6-ME-N	8217890	DPRA-N-2"-6-UB-N

Single acting, spring return	Nose mount	Piston diameter			
		3/4"		1 1/16"	
	1"	8217836	DPRA-N-3/4"-1-SNGP4-N	8217851	DPRA-N-1 1/16"-1-SNGP4-N
	1"	8217837	DPRA-N-3/4"-1-SME-N	8217841	DPRA-N-1 1/16"-1-SME-N



Standards-based cylinders - DSBC, to ISO 15552

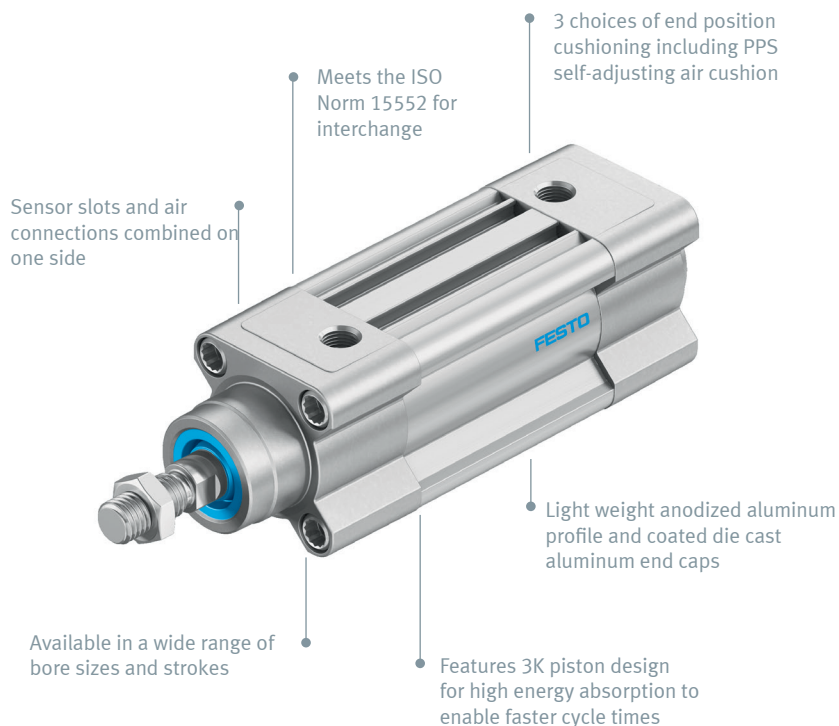

001	Type
DSBC	Standards-based cylinder, double-acting, based on ISO 15552

004	Piston Ø [mm]
---	32, 40, 50, 63, 80

005	Stroke [mm]
---	20, 25, 30, 40, 50, 60, 70, 80, 100, 125, 150, 160, 200, 250, 300, 320, 400, 500

008	Cushioning
PPV	Pneumatic cushioning, adjustable at both ends
PPS	Pneumatic cushioning, self-adjusting at both ends

009	Position sensing
A	Via proximity switch

010	Standard
N3	Conforms to ISO 15552

Actuators and cylinders

Ordering – Basic design

005 Stroke [mm]	004 Piston Ø [mm]					004 Piston Ø [mm]				
	32	40	50	63	80	32	40	50	63	80
	008 Cushioning – 009 Position sensing – 010 Conforms to ISO 15552									
	PPV					PPS				
20	2123069	2123166	2098969	2125490	2126594	2123085	2123780	2102628	2126684	2126636
25	1376422	1376656	1366948	1383578	1383333	1376467	1376903	1376301	1383632	1383366
30	2123070	2123167	2098970	2125491	2126595	2123086	2123781	2102629	2126685	2126637
40	1376423	1376657	1366949	1383579	1383334	1376468	1376904	1376304	1383633	1383367
50	1376424	1376658	1366950	1383580	1383335	1376469	1376905	1376305	1383634	1383368
60	2123071	2123224	2098972	2125492	2126597	2123087	2123782	2102630	2126686	2126638
70	2123072	2123225	2098973	2125493	2126598	2123088	2123783	2102631	2126687	2126639
80	1376425	1376659	1366951	1383581	1383336	1376470	1376906	1376306	1383635	1383369
100	1376426	1376660	1366952	1383582	1383337	1376471	1376907	1376307	1383636	1383370
125	1376427	1376661	1366953	1383583	1383338	1376472	1376908	1376308	1383637	1383371
150	2123073	2123226	2098974	2125494	2126599	2123089	2123784	2102632	2126688	2126640
160	1376428	1376662	1366954	1383584	1383339	1376473	1376909	1376309	1383638	1383372
200	1376429	1376663	1366955	1383585	1383340	1376474	1376910	1376310	1383639	1383373
250	1376430	1376664	1366956	1383586	1383341	1376475	1376911	1376311	1383640	1383374
300	2123074	2123227	2098975	2125495	2126600	2123090	2123785	2102633	2126689	2126641
320	1376431	1376665	1366957	1383587	1383342	1376476	1376912	1376312	1383641	1383375
400	1376432	1376666	1366958	1383588	1383343	1376477	1376913	1376313	1383642	1383376
500	1376433	1376667	1366959	1383589	1383344	1376478	1376914	1376314	1383643	1383377



Round cylinder - DSNU-ISO type

Actuators and cylinders

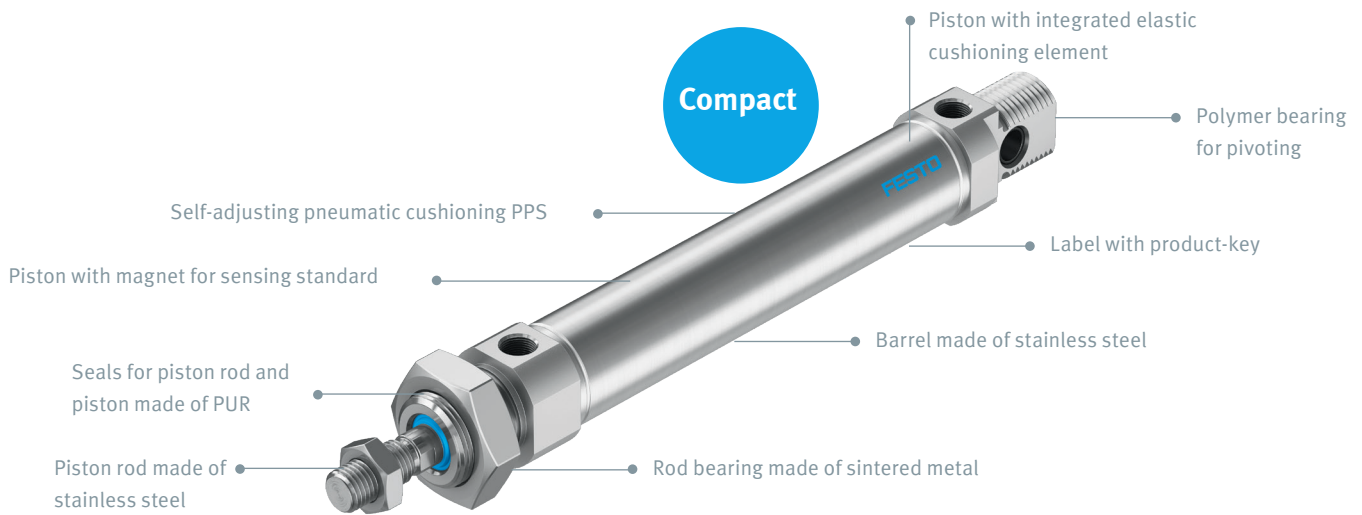

003 Stroke [mm]	002 Piston Ø [mm]													
	10	12	16	20	25	32	16	20	25	32	16	20	25	32
	Cushioning - Position sensing													
	P - A					PPV - A					PPS - A			
10	19183	19189	19198	19207	19218		1908266	1908289	1908312		1908274	1908297	1908320	
15	1908251	1908255	1908259	1908282	1908305		1908267	1908290	1908313		1908275	1908298	1908321	
20	1908252	1908256	1908260	1908283	1908306		1908268	1908291	1908314		1908276	1908299	1908322	
25	19184	19190	19199	19208	19219	195980	33973	33974	33975	196020	559263	559271	559282	559295
30	1908253	1908257	1908261	1908284	1908307		1908269	1908292	1908315		1908277	1908300	1908323	
35			1908262	1908285	1908308		1908270	1908293	1908316		1908278	1908301	1908324	
40	19185	19191	19200	19209	19220	195981	19229	19236	19245	196021	559264	559272	559283	559296
50	19186	19192	19201	19210	19221	195982	19230	19237	19246	196022	559265	559273	559284	559297
60	1908254	1908258	1908263	1908286	1908309		1908271	1908294	1908317		1908279	1908302	1908325	
70			1908264	1908287	1908310		1908272	1908295	1908318		1908280	1908303	1908326	
80	19187	19193	19202	19211	19222	195983	19231	19238	19247	196023	559266	559274	559285	559298
100	19188	19194	19203	19212	19223	195984	19232	19239	19248	196024	559267	559275	559286	559299
125		19195	19204	19213	19224	195985	19233	19240	19249	196025	559268	559276	559287	559300
150			1908265	1908288	1908311		1908273	1908296	1908319		1908281	1908304	1908327	
160		19196	19205	19214	19225	195986	19234	19241	19250	196026	559269	559277	559288	559301
200		19197	19206	19215	19226	195987	19235	19242	19251	196027	559270	559278	559289	559302
250				19216	19227	195988		19243	19252	196028		559279	559290	559303
300				19217	19228			19244	19253			559280	559291	
320				34718	34719	195989		34720	34721	196029		559281	559292	559304
400													559293	
500													559294	

NOTE: Additional sizes are also available. Please contact Festo.



Solid-state cylinder switch - SMT-8M-A (T-slot)

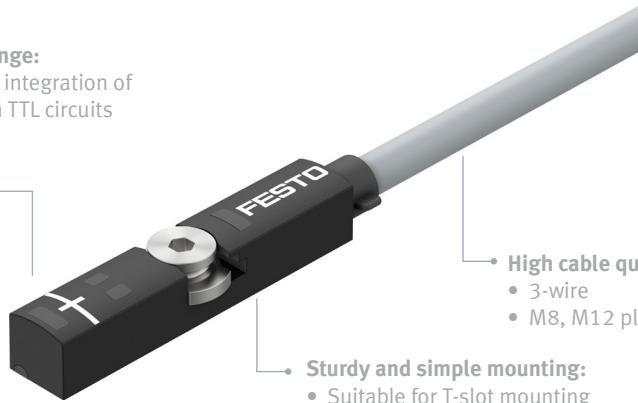

Operating voltage range:

- 5 ... 30 V: for direct integration of the output signal in TTL circuits

2 LEDs Displaying:

- Indicates the safe installation position
- Prevents permanent switching point losses
- Signals switching output "ON"

Protection classes:

- IP65, IP68, IP69K

Switching output:

- 3-wire PNP N/O contact
- 3-wire NPN N/O contact
- Additional variants available see Festo website

High cable quality: energy chain and robot

- 3-wire
- M8, M12 plug and open end

Sturdy and simple mounting:

- Suitable for T-slot mounting
- Captive retaining screw
- Securely retained in the slot

SMT-8M-A is completely reliable in combination with Festo drives – they have been harmonised perfectly and are easy and safe to install.

Part number	Type	Description
574334	SMT-8M-A-PS-24V-E-0,3-M8D	PNP N/O, 30 cm cable, 3-pin M8 plug
574335	SMT-8M-A-PS-24V-E-2,5-OE	PNP N/O, 2.5 m cable, 3-wire open end
574336	SMT-8M-A-PS-24V-E-5,0-OE	PNP N/O, 5.0 m cable, 3-wire open end
574337	SMT-8M-A-PS-24V-E-0,3-M12	PNP N/O, 30 cm cable, 3-pin M12 plug
574338	SMT-8M-A-NS-24V-E-2,5-OE	NPN N/O, 2.5 m cable, 3-wire open end
574339	SMT-8M-A-NS-24V-E-0,3-M8D	NPN N/O, 30 cm cable, 3-pin M8 plug

Solid-state cylinder switch - SMT-10M (C-Slot)

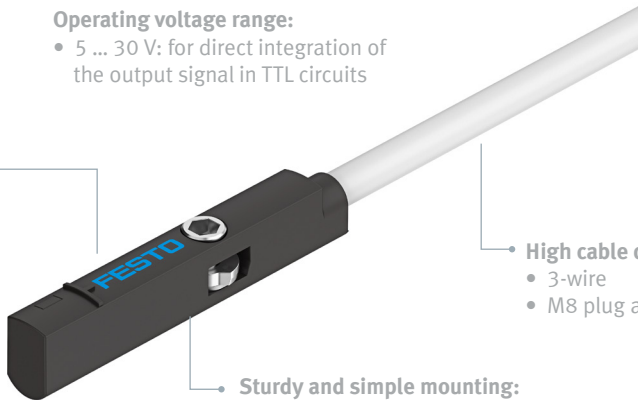

Operating voltage range:

- 5 ... 30 V: for direct integration of the output signal in TTL circuits

LED Displaying:

- Indicates the installation position
- Signals switching output "ON"

Protection classes:

- IP65, IP68

Switching output:

- 3-wire PNP N/O contact
- 3-wire NPN N/O contact
- Additional variants available see Festo website

High cable quality: energy chain and robot

- 3-wire
- M8 plug and open end

Sturdy and simple mounting:

- Suitable for C-slot mounting
- Captive retaining screw
- Securely retained in the slot
- Available in both longitudinal and transverse cable position

SMT-10M is completely reliable in combination with Festo drives – they have been harmonised perfectly and are easy and safe to install.

Part number	Type	Description
551373	SMT-10M-PS-24V-E-2,5-L-OE	PNP N/O, 2.5 m cable, 3-wire open end (longitudinal cable position)
551375	SMT-10M-PS-24V-E-0,3-L-M8D	PNP N/O, 30 cm cable, 3-pin M8 plug (longitudinal cable position)
551376	SMT-10M-PS-24V-E-0,3-Q-M8D	PNP N/O, 30 cm cable, 3-pin M8 plug (transverse cable position)
551377	SMT-10M-NS-24V-E-2,5-L-OE	NPN N/O, 2.5 m cable, 3-wire open end (longitudinal cable position)
551379	SMT-10M-NS-24V-E-0,3-L-M8D	NPN N/O, 30 cm cable, 3-pin M8 plug (longitudinal cable position)



Compact valves - VUVG-L/B [24V DC]

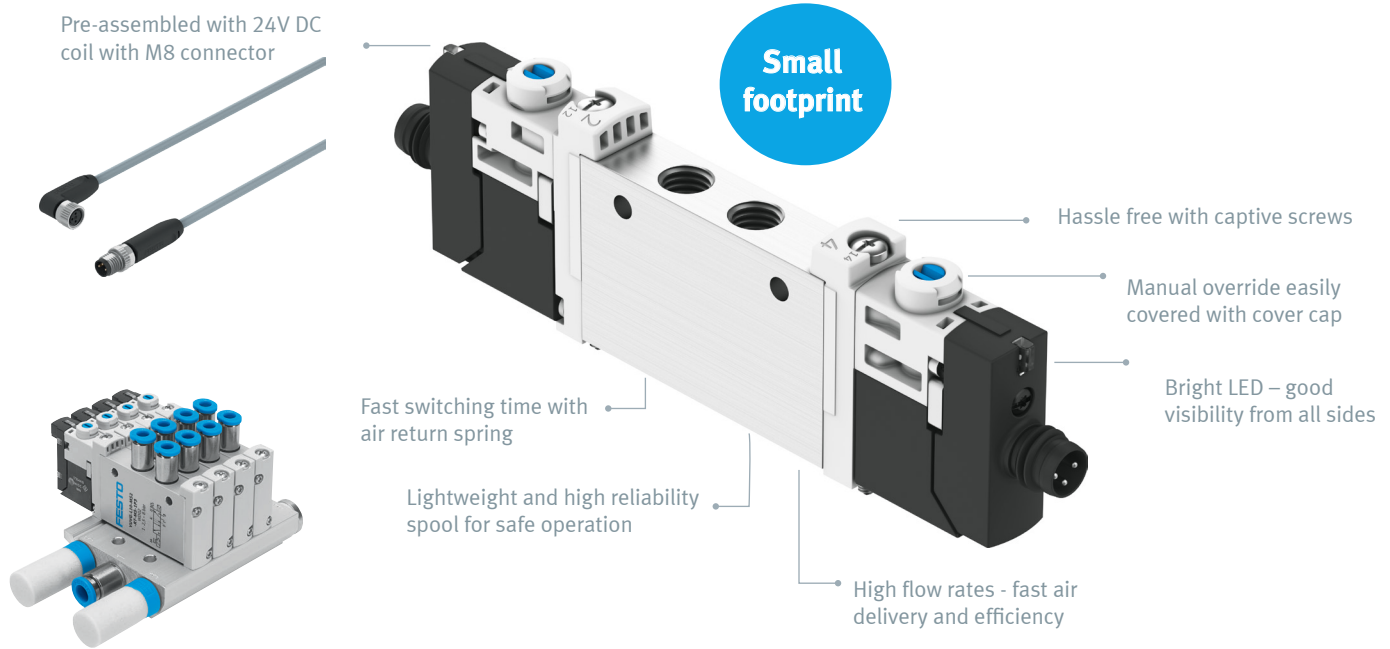

With electrical sub-base R8 [M8, 3-pin]

Connection size	Width [mm]	Part no	Description	Flow rate	Part no	Description	Flow rate
In-line valves - L				Sub-base valves - B (connection via supply manifold)			
5/2-way with solenoid coil, single solenoid, mechanical spring 24V DC							
M5	10	8031472	VUVG-L10-M52-MT-M5-1R8L	190 l/min	578157	VUVG-B10-M52-MZT-F-1R8L	210 l/min
G1/8	14	8031508	VUVG-L14-M52-MT-G18-1R8L	780 l/min	578158	VUVG-B14-M52-MZT-F-1R8L	520 l/min
G1/4	18	8031532	VUVG-L18-M52-MT-G14-1R8L	1300 l/min	8031544	VUVG-B18-M52-MZT-F-1R8L	1000 l/min
5/2-way with solenoid coil, single solenoid, pneumatic mixed spring 24V DC							
M5	10	572634	VUVG-L10-M52-RT-M5-1R8L	220 l/min	574237	VUVG-B10-M52-RZT-F-1R8L	210 l/min
G1/8	14	574229	VUVG-L14-M52-AT-G18-1R8L	780 l/min	574245	VUVG-B14-M52-AZT-F-1R8L	520 l/min
G1/4	18	8031531	VUVG-L18-M52-RT-G14-1R8L	1300 l/min	8031543	VUVG-B18-M52-RZT-F-1R8L	1000 l/min
5/2-way with solenoid coil double solenoid 24V DC							
M5	10	576664	VUVG-L10-B52-T-M5-1R8L	220 l/min	574238	VUVG-B10-B52-ZT-F-1R8L	210 l/min
G1/8	14	574230	VUVG-L14-B52-T-G18-1R8L	700 l/min	574246	VUVG-B14-B52-ZT-F-1R8L	570 l/min
G1/4	18	8031533	VUVG-L18-B52-T-G14-1R8L	1370 l/min	8031545	VUVG-B18-B52-ZT-F-1R8L	1000 l/min
2 x 3/2-way with solenoid coil, normally closed, mechanical spring 24V DC							
M5	10	8031468	VUVG-L10-T32C-MT-M5-1R8L	135 l/min	8031492	VUVG-B10-T32C-MZT-F-1R8L	130 l/min
G1/8	14	8031504	VUVG-L14-T32C-MT-G18-1R8L	550 l/min	578248	VUVG-B14-T32C-MZT-F-1R8L	430 l/min
G1/4	18	8031528	VUVG-L18-T32C-MT-G14-1R8L	870 l/min	8031540	VUVG-B18-T32C-MZT-F-1R8L	800 l/min
2 x 3/2-way with solenoid coil, normally closed, pneumatic spring 24V DC							
M5	10	577347	VUVG-L10-T32C-AT-M5-1R8L	150 l/min	574234	VUVG-B10-T32C-AZT-F-1R8L	150 l/min
G1/8	14	574226	VUVG-L14-T32C-AT-G18-1R8L	560 l/min	574242	VUVG-B14-T32C-AZT-F-1R8L	510 l/min
G1/4	18	8031525	VUVG-L18-T32C-AT-G14-1R8L	880 l/min	8031537	VUVG-B18-T32C-AZT-F-1R8L	800 l/min

Connection size	Width [mm]	Part no	Description	Flow rate	Part no	Description	Flow rate
In-line valves - L				Sub-base valves - B (connection via supply manifold)			
5/3-way with solenoid coil, blocked, 24V DC							
M5	10	577346	VUVG-L10-P53C-T-M5-1R8L	210 l/min	574239	VUVG-B10-P53C-ZT-F-1R8L	200 l/min
G1/8	14	574231	VUVG-L14-P53C-T-G18-1R8L	650 l/min	574247	VUVG-B14-P53C-ZT-F-1R8L	520 l/min
G1/4	18	8031534	VUVG-L18-P53C-T-G14-1R8L	1200 l/min	8031546	VUVG-B18-P53C-ZT-F-1R8L	950 l/min
5/3-way with solenoid coil, exhausted, 24V DC							
M5	10	8031475	VUVG-L10-P53E-T-M5-1R8L	210 l/min	574241	VUVG-B10-P53E-ZT-F-1R8L	200 l/min
G1/8	14	574233	VUVG-L14-P53E-T-G18-1R8L	560 l/min	574249	VUVG-B14-P53E-ZT-F-1R8L	460 l/min
G1/4	18	8031536	VUVG-L18-P53U-T-G14-1R8L	1050 l/min	8031547	VUVG-B18-P53E-ZT-F-1R8L	950 l/min
5/3-way with solenoid coil, pressurized, 24V DC							
M5	10	8031476	VUVG-L10-P53U-T-M5-1R8L	210 l/min	574240	VUVG-B10-P53U-ZT-F-1R8L	200 l/min
G1/8	14	574232	VUVG-L14-P53U-T-G18-1R8L	560 l/min	574248	VUVG-B14-P53U-ZT-F-1R8L	500 l/min
G1/4	18	8031535	VUVG-L18-P53E-T-G14-1R8L	1000 l/min	8031548	VUVG-B18-P53U-ZT-F-1R8L	950 l/min
Electrical connections							
R8	M8, 3-pin open end, 2.5 m length straight		8078223			NEBA-M8G3-U-2.5-N-LE3	
R8	M8, 3-pin open end, 2.5 m length angled		8078223			NEBA-M8W3-U-2.5-N-LE3	

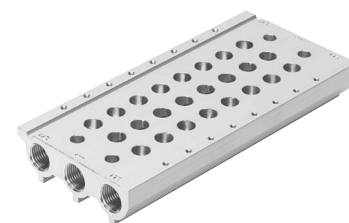

Accessories: Manifold options with valves via 572230 VTUG-S

Valve size	Part no	Description	Manifold stations	Part no	Description	Manifold stations		
Semi in-line accessories				Sub-base accessories				
10	566558	Manifold rail	VABM-L1-10S-G18-2	2	566582	Manifold rail	VABM-L1-10W-G18-2	2
10	566560	Manifold rail	VABM-L1-10S-G18-4	4	566584	Manifold rail	VABM-L1-10W-G18-4	4
10	566562	Manifold rail	VABM-L1-10S-G18-6	6	566586	Manifold rail	VABM-L1-10W-G18-6	6
10	566564	Manifold rail	VABM-L1-10S-G18-8	8	566588	Manifold rail	VABM-L1-10W-G18-8	8
14	566618	Manifold rail	VABM-L1-14S-G14-2	2	566642	Manifold rail	VABM-L1-14W-G14-2	2
14	566620	Manifold rail	VABM-L1-14S-G14-4	4	566644	Manifold rail	VABM-L1-14W-G14-4	4
14	566622	Manifold rail	VABM-L1-14S-G14-6	6	566646	Manifold rail	VABM-L1-14W-G14-6	6
14	566624	Manifold rail	VABM-L1-14S-G14-8	8	566648	Manifold rail	VABM-L1-14W-G14-8	8
18	574455	Manifold rail	VABM-L1-18S-G38-2	2	574467	Manifold rail	VABM-L1-18W-G38-2	2
18	574457	Manifold rail	VABM-L1-18S-G38-4	4	574469	Manifold rail	VABM-L1-18W-G38-4	4
18	574459	Manifold rail	VABM-L1-18S-G38-6	6	574471	Manifold rail	VABM-L1-18W-G38-6	6
18	574461	Manifold rail	VABM-L1-18S-G38-8	8	574473	Manifold rail	VABM-L1-18W-G38-8	8
10	566672	Seal	VABD-L1-10X-S-M5	-	566674	Seal	VABD-L1-10B-S-M7	-
14	566675	Seal	VABD-L1-14X-S-G18	-	566676	Seal	VABD-L1-14B-S-G18	-
18	574479	Seal	VABD-L1-18X-S-G14	-	574480	Seal	VABD-L1-18B-S-G14	-



Air preparation - MS series

Air preparation



Integrated lockability for lock out tag out & to prevent tampering with set pressures.

Small size, Large flow

Equipped with newly redesigned auto-drain with higher reliability and enhanced performance



Suitable for standard applications as well as applications with very high air quality requirements.

Available as individual components or pre-assembled combinations in-stock.

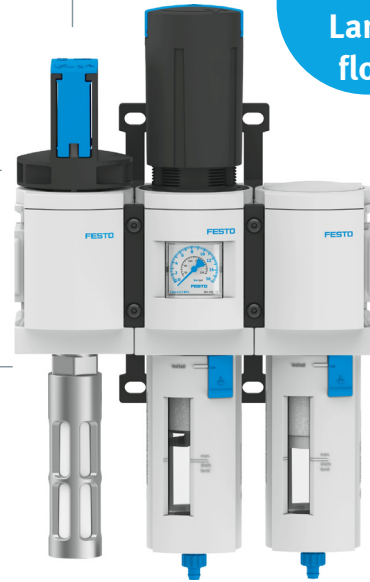

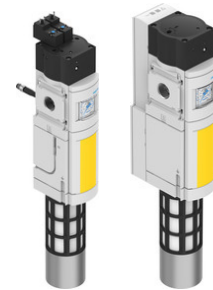

Incorporate the MS6-SV safety valves for fast and reliable exhausting of systems up to Performance Level d or e, certified to EN ISO 13849-1





LR-Regulator







Size	Housing material	Port size	Pressure gauge scale	Weight [g]	Flow [l/m]	Part number	Type
 MS4	LR regulator, regulating range 0.3 ... 4.0 Bar						
	Metal	G1/4	bar/psi	225	2100	529415	MS4-LR-1/4-D5-AS
		1/4 NPT				531418	MS4N-LR-1/4-D5-AS
	LR regulator, regulating range 0.3 ... 7 bar						
	Metal	G1/4	bar/psi	225	1800	529417	MS4-LR-1/4-D6-AS
		1/4 NPT				531422	MS4N-LR-1/4-D6-AS
LR regulator, regulating range 0.5 ... 10.0 Bar							
Metal	G1/4	bar/psi	225	1700	529419	MS4-LR-1/4-D7-AS	
	1/4 NPT				531426	MS4N-LR-1/4-D7-AS	
 MS6	LR regulator, regulating range 0.3 ... 4.0 Bar						
	Metal	G1/2	bar/psi	730	7500	529989	MS6-LR-1/2-D5-AS
		1/2 NPT				531443	MS6N-LR-1/2-D5-AS
	LR regulator, regulating range 0.3 ... 7.0 Bar						
	Metal	G1/2	bar/psi	730	6500	529991	MS6-LR-1/2-D6-AS
		1/2 NPT				531449	MS6N-LR-1/2-D6-AS
LR regulator, regulating range 0.5 ... 10.0 Bar							
Metal	G1/2	bar/psi	730	5500	529993	MS6-LR-1/2-D7-AS	
	1/2 NPT				531455	MS6N-LR-1/2-D7-AS	



LFR-Filter/Regulator										QR	
Size	Housing material	Port size	Filtration level [µm]	Pressure gauge scale	Condensate draining	Weight [g]	Flow rate [l/m]	Part number	Type		
	LFR regulator, regulating range 0.3 ... 7 bar										
	Metal	G1/4	5	bar/psi	Manual	275	1500	529144	MS4-LFR-1/4-D6-CRM-AS		
					Auto			529146	MS4-LFR-1/4-D6-CRV-AS		
			40		Manual			275	1700	529148	MS4-LFR-1/4-D6-ERM-AS
					Auto					529150	MS4-LFR-1/4-D6-ERV-AS
		1/4 NPT	5		275	1500	Manual	531229	MS4N-LFR-1/4-D6-CRM-AS		
							Auto	531233	MS4N-LFR-1/4-D6-CRV-AS		
			40		275	1700	Manual	531221	MS4N-LFR-1/4-D6-ERM-AS		
							Auto	531225	MS4N-LFR-1/4-D6-ERV-AS		
	LFR regulator, regulating range 0.5 ... 10.0 Bar										
	Metal	G1/4	5	bar/psi	Manual	275	1200	529152	MS4-LFR-1/4-D7-CRM-AS		
					Auto			529154	MS4-LFR-1/4-D7-CRV-AS		
			40		275			1500	Manual	529156	MS4-LFR-1/4-D7-ERM-AS
									Auto	529158	MS4-LFR-1/4-D7-ERV-AS
		1/4 NPT	5		275	1200	Manual	531213	MS4N-LFR-1/4-D7-CRM-AS		
							Auto	531217	MS4N-LFR-1/4-D7-CRV-AS		
40			275		1500	Manual	531205	MS4N-LFR-1/4-D7-ERM-AS			
						Auto	531209	MS4N-LFR-1/4-D7-ERV-AS			



LFR-Filter/Regulator										QR	
Size	Housing material	Port size	Filtration level [µm]	Pressure gauge scale	Condensate draining	Weight [g]	Flow rate [l/m]	Part number	Type		
	LFR regulator, regulating range 0.3 ... 7.0 Bar										
	Metal	G1/2	5	bar/psi	Manual	875	5600	529176	MS6-LFR-1/2-D6-CRM-AS		
					Auto			529178	MS6-LFR-1/2-D6-CRV-AS		
			40		875			6200	Manual	529180	MS6-LFR-1/2-D6-ERM-AS
									Auto	529182	MS6-LFR-1/2-D6-ERV-AS
		1/2 NPT	5		875	4000	Manual	531306	MS6N-LFR-1/2-D6-CRM-AS		
							Auto	531312	MS6N-LFR-1/2-D6-CRV-AS		
			40		875	4500	Manual	531300	MS6N-LFR-1/2-D6-ERV-AS		
							Auto	531294	MS6N-LFR-1/2-D6-ERM-AS		
	LFR regulator, regulating range 0.5 ... 10.0 Bar										
	Metal	G1/2	5	bar/psi	Manual	875	4000	529184	MS6-LFR-1/2-D7-CRM-AS		
					Auto			529186	MS6-LFR-1/2-D7-CRV-AS		
			40		875			4500	Manual	529188	MS6-LFR-1/2-D7-ERM-AS
									Auto	529190	MS6-LFR-1/2-D7-ERV-AS
		1/2 NPT	5		875	4000	Manual	531282	MS6N-LFR-1/2-D7-CRM-AS		
							Auto	531288	MS6N-LFR-1/2-D7-CRV-AS		
40			875		4500	Manual	531270	MS6N-LFR-1/2-D7-ERM-AS			
						Auto	531276	MS6N-LFR-1/2-D7-ERV-AS			



LWS - Water Separator								QR
Size	Housing material	Port size	Condensate draining	Weight [g]	Flow rate [l/m]	Part number	Type	
	Metal	G1/2	Automatic	820	3800	529679	MS6-LWS-1/2-U-V	
		1/2 NPT				564873	MS6N-LWS-1/2-U-V	

LF-Filter									
Size	Housing material	Port size	Filtration level [µm]	Condensate draining	Weight [g]	Flow rate [l/m]	Part number	Type	
MS4 	Metal	G1/4	5	Manual	189	1300	529395	MS4-LF-1/4-CRM	
				Auto			529397	MS4-LF-1/4-CRV	
			40	Manual			1700	529399	MS4-LF-1/4-ERM
				Auto				529401	MS4-LF-1/4-ERV
		1/4 NPT	5	Manual		1300		531489	MS4N-LF-1/4-CRM
				Auto				531493	MS4N-LF-1/4-CRV
			40	Manual			1700	531485	MS4N-LF-1/4-ERM
				Auto				531481	MS4N-LF-1/4-ERV
MS6 	Metal	G1/2	5	Manual	500	3200		529607	MS6-LF-1/2-CRM
				Auto				529609	MS6-LF-1/2-CRV
			40	Manual			4100	529615	MS6-LF-1/2-ERM
				Auto				529617	MS6-LF-1/2-ERV
		1/2 NPT	5	Manual		3200		531526	MS6N-LF-1/2-CRM
				Auto				531532	MS6N-LF-1/2-CRV
			40	Manual			4100	531520	MS6N-LF-1/2-ERM
				Auto				531514	MS6N-LF-1/2-ERV

LFM-Filter										
Size	Housing material	Port size	Filtration level [µm]	Condensate draining	Weight [g]	Flow rate [l/m]	Part number	Type		
MS4 	Metal	G1/4	1	Manual	190	360	529461	MS4-LFM-1/4-BRM		
			0.01				529459	MS4-LFM-1/4-ARM		
		1/4 NPT	1				600	950	531810	MS4N-LFM-1/4-BRM
			0.01						531812	MS4N-LFM-1/4-ARM
MS6 		G1/2	1		900	529659		MS6-LFM-1/2-BRM		
			0.01			529655		MS6-LFM-1/2-ARM		
		1/2 NPT	1			900	531849	MS6N-LFM-1/2-BRM		
			0.01				531861	MS6N-LFM-1/2-ARM		

LFX-Filter								
Size	Housing material	Port size	Filtration level [µm]	Condensate draining	Weight [g]	Flow rate [l/m]	Part number	Type
MS4 	Metal	G1/4	Active carbon	Manual	190	360	529467	MS4-LFX-1/4-R
		1/4 NPT					531764	MS4N-LFX-1/4-R
MS6 		G1/2			600	900	529679	MS6-LFX-1/2-R
		1/2 NPT					531921	MS6N-LFX-1/2-R

EM1 - On/Off valve								
Size	Housing material	Port size	With silencer	Weight [g]	Flow rate [l/m]	Part number	Type	
MS4 	Metal	G1/4	Yes	210	2200	541259	MS4-EM1-1/4-S	
			No	190		541258	MS4-EM1-1/4	
		1/4 NPT	Yes	210		541281	MS4N-EM1-1/4-S	
			No	190		541280	MS4N-EM1-1/4	
MS6 		G1/2	Yes	655	8700	541268	MS6-EM1-1/2-S	
			No	580		541267	MS6-EM1-1/2	
		1/2 NPT	Yes	655		541290	MS6N-EM1-1/2-S	
			No	580		541289	MS6N-EM1-1/2	

EE - Electric On/Off valve										
Size	Housing material	Port size	Voltage	With silencer	Weight [g]	Flow rate [l/m]	Part number	Type		
MS4 	Metal	G1/4	10V24	Yes	289	2000	542598	MS4-EE-1/4-10V24-S		
				No	273		542578	MS4-EE-1/4-10V24		
		Yes		289	542608		MS4N-EE-1/4-10V24-S			
		No		273	542588		MS4N-EE-1/4-10V24			
MS6 		G1/2		7000	Yes	816	542602	MS6-EE-1/2-10V24-S		
					No	740	542582	MS6-EE-1/2-10V24		
		1/2 NPT			Yes	816	542612	MS6N-EE-1/2-10V24-S		
					No	740	542593	MS6N-EE-1/2-10V24		

DL - Soft Start - Pneumatically Actuated							
Size	Housing material	Port size	Weight [g]	Flow rate [l/m]	Part number	Type	
MS4 	Metal	G1/4	213	2000	529531	MS4-DL-1/4	
		1/4 NPT			531991	MS4N-DL-1/4	
MS6		G1/2	650	6450	529817	MS6-DL-1/2	
		1/2 NPT			532024	MS6N-DL-1/2	

FRM - Distributor Block								
Size	Housing material	Port size	Outlet port size	Body width [mm]	Weight [g]	Flow rate [l/m]	Part number	Type
MS4 	Metal	G1/4	G1/4	40	165	500 - 4600	529555	MS4-FRM-1/4
		1/4 NPT	1/4 NPT				531949	MS4N-FRM-1/4
MS6		G1/2	G1/2	62	458	2700 - 14700	529853	MS6-FRM-1/2
		1/2 NPT	1/2 NPT				531966	MS6N-FRM-1/2

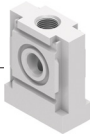
FRM - FRZ - Distributor Block								
Size	Housing material	Port size	Outlet port size	Body width [mm]	Weight [g]	Flow rate [l/m]	Part number	Type
MS4 	Metal	G1/4	G1/4	50	60	4050	549336	MS4-FRM-FRZ
		1/4 NPT	1/4 NPT				554101	MS4N-FRM-FRZ
MS6		G1/2	G1/2	31	163	14600	549337	MS6-FRM-FRZ
		1/2 NPT	1/2 NPT				554102	MS6N-FRM-FRZ

SV - Safety Valve										
Size	Housing material	Port size	Performance level	Voltage	Sensor connection	With silencer	Weight [g]	Flow rate [l/m]	Part number	Description
MS6 	Metal	G1/2	C	10V24	n/a	Yes	1006	5700	8001469	MS6-SV-1/2-C-10V24-S
			D	10V24	M8	Yes	2110		8038490	MS6-SV-1/2-D-10V24-2M8-SO-AG
				10V24P	M12	Yes		8038491	MS6-SV-1/2-D-10V24P-2M12-SO-AG	
			E	10V24	MPx(order separately)	Yes	2200	548717	MS6-SV-1/2-E-10V24-SO-AG	
						No		548715	MS6-SV-1/2-E-10V24-AG	



QB standard inch and hybrid push-in fittings and connectors

Fittings and tubing

Standard models
UNF 10-32
NPT 1/8, 1/4, 3/8, 1/2

Hybrid Models
Metric M3, M4, M5
ISO-R 1/8, 1/4, 3/8, 1/2

High strength PBT body
with nickel plated threading

POM-Release ring for quick
and easy tube release

PTFE thread sealant for
leak free connection

Inch tube connections 1/8, 5/32, 1/4, 5/16,
3/8, 1/2 for both **standard** and **hybrid** models

QB standard, mini - push-in fittings (inch)

Push-in fitting (external hex)					
Image	D1 (thread)	D2 (tube)	Pkg unit	Part no.	Description
	10-32 UNF	1/8	10	533266	QBM-10-32-UNF-1/8-U
	10-32 UNF	5/32	10	572303	QBM-10-32-UNF-5/32-U
	10-32 UNF	1/4	10	573050	QBM-10-32-UNF-1/4-U
	1/8 NPT	1/8	10	533270	QBM-1/8-1/8-U
	1/8 NPT	5/32	10	572305	QBM-1/8-5/32-U
	1/8 NPT	1/4	10	573051	QBM-1/8-1/4-U
	1/4 NPT	1/8	10	572306	QBM-1/4-1/8-U
	1/4 NPT	1/4	10	573052	QBM-1/4-1/4-U

Push-in fitting (with internal hex)					
Image	D1 (thread)	D2 (tube)	Pkg unit	Part no.	Description
	10-32 UNF	1/8	10	572311	QBM-10-32-UNF-1/8-I-U
	10-32 UNF	5/32	10	572312	QBM-10-32-UNF-5/32-I-U
	10-32 UNF	1/4	10	573054	QBM-10-32-UNF-1/4-I-U
	1/8 NPT	1/4	10	573055	QBM-1/8-1/4-I-U

Push-in T-fitting					
Image	D1 (thread)	D2 (tube)	Pkg unit	Part no.	Description
	10-32 UNF	1/8	10	533304	QBMT-10-32-UNF-1/8-U
	1/8 NPT	1/8	10	533308	QBMT-1/8-1/8-U

Push-in L-fitting					
Image	D1 (thread)	D2 (tube)	Pkg unit	Part no.	Description
	10-32 UNF	1/8	10	533285	QBML-10-32-UNF-1/8-U
	10-32 UNF	5/32	10	572308	QBML-10-32-UNF-5/32-U
	10-32 UNF	1/4	10	573059	QBML-10-32-UNF-1/4-U
	1/4 NPT	1/8	10	572310	QBML-1/4-1/8-U
	1/4 NPT	1/4	10	573061	QBML-1/4-1/4-U
	1/8 NPT	1/8	10	533289	QBML-1/8-1/8-U
	1/8 NPT	1/4	10	573060	QBML-1/8-1/4-U



QB standard - push-in fittings (inch)

Push-in fitting (external Hex)					
Image	D1 (thread)	D2 (tube)	Pkg unit	Part no.	Description
	10-32 UNF	5/32	10	533267	QB-10-32-UNF-5/32-U
	10-32 UNF	1/4	10	533269	QB-10-32-UNF-1/4-U
	1/8 NPT	5/32	10	533271	QB-1/8-5/32-U
	1/8 NPT	1/4	10	533273	QB-1/8-1/4-U
	1/8 NPT	5/16	10	533274	QB-1/8-5/16-U
	1/8 NPT	3/8	10	567773	QB-1/8-3/8-U
	1/4 NPT	5/32	10	567772	QB-1/4-5/32-U
	1/4 NPT	1/4	10	533276	QB-1/4-1/4-U
	1/4 NPT	5/16	10	533277	QB-1/4-5/16-U
	1/4 NPT	3/8	10	533278	QB-1/4-3/8-U
	1/4 NPT	1/2	10	567771	QB-1/4-1/2-U
	3/8 NPT	1/4	10	533279	QB-3/8-1/4-U
	3/8 NPT	5/16	10	533280	QB-3/8-5/16-U
	3/8 NPT	3/8	5	533281	QB-1/2-1/2-U
	3/8 NPT	1/2	5	533282	QB-3/8-1/2-U
	1/2 NPT	5/16	10	567770	QB-1/2-5/16-U
	1/2 NPT	3/8	5	533283	QB-1/2-3/8-U
	1/2 NPT	1/2	5	533284	QB-1/2-1/2-U

Push-in L-fitting					
Image	D1 (thread)	D2 (tube)	Pkg unit	Part no.	Description
	10-32 UNF-2A	5/32	10	533286	QBL-10-32-UNF-5/32-U
	10-32 UNF-2A	1/4	10	533288	QBL-10-32-UNF-1/4-U
	1/8 NPT	5/32	10	533290	QBL-1/8-5/32-U
	1/8 NPT	1/4	10	533292	QBL-1/8-1/4-U
	1/8 NPT	5/16	10	533293	QBL-1/8-5/16-U
	1/8 NPT	3/8	10	567777	QBL-1/8-3/8-U
	1/4 NPT	5/32	10	567776	QBL-1/4-5/32-U
	1/4 NPT	1/4	10	533295	QBL-1/4-1/4-U
	1/4 NPT	5/16	10	533296	QBL-1/4-5/16-U
	1/4 NPT	3/8	5	533297	QBL-1/4-3/8-U
	1/4 NPT	1/2	5	567775	QBL-1/4-1/2-U
	3/8 NPT	1/4	5	533298	QBL-3/8-1/4-U
	3/8 NPT	5/16	5	533299	QBL-3/8-5/16-U
	3/8 NPT	3/8	5	533300	QBL-3/8-3/8-U
	3/8 NPT	1/2	5	533301	QBL-3/8-1/2-U
	1/2 NPT	3/8	5	533302	QBL-1/2-3/8-U
	1/2 NPT	1/2	5	533303	QBL-1/2-1/2-U

Push-in fitting (with internal hex)					
Image	D1 (thread)	D2 (tube)	Pkg unit	Part no.	Description
	10-32 UNF	1/4	10	572316	QB-10-32-UNF-1/4-I-U
	1/8 NPT	5/32	10	572317	QB-1/8-5/32-I-U
	1/8 NPT	1/4	10	572318	QB-1/8-1/4-I-U
	1/8 NPT	5/16	10	572319	QB-1/8-5/16-I-U
	1/4 NPT	1/4	10	572320	QB-1/4-1/4-I-U
	1/4 NPT	5/16	10	572321	QB-1/4-5/16-I-U
	1/4 NPT	3/8	10	572322	QB-1/4-3/8-I-U
	3/8 NPT	5/16	10	572323	QB-3/8-5/16-I-U
	3/8 NPT	3/8	10	572324	QB-3/8-3/8-I-U
	3/8 NPT	1/2	10	572325	QB-3/8-1/2-I-U
	1/2 NPT	1/2	10	572326	QB-1/2-1/2-I-U

Push-in fitting (female)					
Image	D1 (thread)	D2 (tube)	Pkg unit	Part no.	Description
	1/8 NPT	5/32	10	564636	QBF-1/8-5/32-U
	1/8 NPT	1/4	10	564638	QBF-1/8-1/4-U
	1/8 NPT	5/16	10	564639	QBF-1/8-5/16-U
	1/8 NPT	3/8	10	564640	QBF-1/8-3/8-U
	1/4 NPT	5/32	10	564642	QBF-1/4-5/32-U
	1/4 NPT	1/4	10	564644	QBF-1/4-1/4-U
	1/4 NPT	5/16	10	564645	QBF-1/4-5/16-U
	1/4 NPT	3/8	10	564646	QBF-1/4-3/8-U
	1/4 NPT	1/2	5	564647	QBF-1/4-1/2-U
	3/8 NPT	1/4	10	564648	QBF-3/8-1/4-U
	3/8 NPT	5/16	10	567774	QBF-3/8-5/16-U
	3/8 NPT	3/8	10	564649	QBF-3/8-3/8-U
	3/8 NPT	1/2	5	564650	QBF-3/8-1/2-U
	1/2 NPT	5/16	10	564651	QBF-1/2-5/16-U
	1/2 NPT	3/8	5	564652	QBF-1/2-3/8-U

Push-in T-fitting					
Image	D1 (thread)	D2 (tube)	Pkg unit	Part no.	Description
	10-32 UNF	5/32	10	533305	QBT-10-32-UNF-5/32-U
	10-32 UNF	1/4	10	533307	QBT-10-32-UNF-1/4-U
	1/8 NPT	5/32	10	533309	QBT-1/8-5/32-U
	1/8 NPT	1/4	10	533311	QBT-1/8-1/4-U
	1/8 NPT	5/16	5	533312	QBT-1/8-5/16-U
	1/8 NPT	3/8	5	567767	QBT-1/8-3/8-U
	1/4 NPT	5/32	10	567778	QBT-1/4-5/32-U
	1/4 NPT	1/4	5	533314	QBT-1/4-1/4-U
	1/4 NPT	5/16	5	533315	QBT-1/4-5/16-U
	1/4 NPT	3/8	5	533316	QBT-1/4-3/8-U
	1/4 NPT	1/2	5	567768	QBT-1/4-1/2-U
	3/8 NPT	1/4	5	533317	QBT-3/8-1/4-U
	3/8 NPT	5/16	5	533318	QBT-3/8-5/16-U
	3/8 NPT	3/8	5	533319	QBT-3/8-3/8-U
	3/8 NPT	1/2	1	533320	QBT-3/8-1/2-U
	1/2 NPT	3/8	5	533321	QBT-1/2-3/8-U
	1/2 NPT	1/2	1	533322	QBT-1/2-1/2-U

Push-in Y-fitting					
Image	D1 (thread)	D2 (tube)	Pkg unit	Part no.	Description
	10-32 UNF	5/32	10	564684	QBY-10-32-UNF-5/32-U
	1/8 NPT	5/32	10	564687	QBY-1/8-5/32-U
	1/8 NPT	1/4	10	564689	QBY-1/8-1/4-U
	1/8 NPT	5/16	10	564690	QBY-1/8-5/16-U
	1/8 NPT	3/8	5	564691	QBY-1/8-3/8-U
	1/4 NPT	5/32	10	564692	QBY-1/4-5/32-U
	1/4 NPT	1/4	10	564694	QBY-1/4-1/4-U
	1/4 NPT	5/16	10	564695	QBY-1/4-5/16-U
	1/4 NPT	3/8	5	564696	QBY-1/4-3/8-U
	1/4 NPT	1/2	5	564697	QBY-1/4-1/2-U
	3/8 NPT	1/4	10	564698	QBY-3/8-1/4-U
	3/8 NPT	5/16	10	564700	QBY-3/8-5/16-U
	3/8 NPT	3/8	5	564701	QBY-3/8-3/8-U
	3/8 NPT	1/2	5	564702	QBY-3/8-1/2-U
	1/2 NPT	5/16	5	564703	QBY-1/2-5/16-U
	1/2 NPT	3/8	5	564704	QBY-1/2-3/8-U
	1/2 NPT	1/2	5	564705	QBY-1/2-1/2-U

Push-in fitting (female)					
Image	D1 (thread)	D2 (tube)	Pkg unit	Part no.	Description
	1/8 NPT	1/4	1	153770	QSSF-1/8-1/4-U
	1/8 NPT	5/16	1	153772	QSSF-1/8-5/16-U
	1/4 NPT	1/4	1	153771	QSSF-1/4-1/4-U
	1/4 NPT	5/16	1	153773	QSSF-1/4-5/16-U
	1/4 NPT	3/8	1	153775	QSSF-1/4-3/8-U
	3/8 NPT	5/16	1	153774	QSSF-3/8-5/16-U
	3/8 NPT	3/8	1	153776	QSSF-3/8-3/8-U
	3/8 NPT	1/2	1	153777	QSSF-3/8-1/2-U
	1/2 NPT	1/2	1	153778	QSSF-1/2-1/2-U

QB standard, mini - push-in connectors (inch)

Push-in connector					
Image	D1 (tube)	D2 (tube)	Pkg unit	Part no.	Description
	1/8	1/8	10	572277	QBM-1/8T-U
	5/32	5/32	10	572278	QBM-5/32T-U
	1/4	1/4	10	573056	QBM-1/4T-U

Push-in T-connector					
Image	D1 (tube)	D2 (tube)	Pkg unit	Part no.	Description
	1/8	1/8	10	572293	QBMT-1/8T-U
	5/32	5/32	10	572294	QBMT-5/32T-U
	1/4	1/4	10	573069	QBMT-1/4T-U

Push-in Y-connector					
Image	D1 (tube)	D2 (tube)	Pkg unit	Part no.	Description
	1/8	1/8	10	572299	QBMY-1/8T-U
	5/32	5/32	10	572300	QBMY-5/32T-U
	1/4	1/4	10	573073	QBMY-1/4T-U

Blanking Plug					
Image	D1 (thread)	D2 (tube)	Pkg unit	Part no.	Description
	-	1/8	10	572281	QBMC-1/8H-U



QB standard - push-in connectors (inch)

Push-in connector (reducing)					
Image	D1 (tube)	D2 (tube)	Pkg unit	Part no.	Description
	1/4	5/32	10	564798	QB-1/4T-5/32-U
	5/16	5/32	10	564800	QB-5/16T-5/32-U
	5/16	1/4	10	564801	QB-5/16T-1/4-U
	3/8	1/4	10	564802	QB-3/8T-1/4-U
	3/8	5/16	10	564803	QB-3/8T-5/16-U
	1/2	3/8	5	564804	QB-1/2T-3/8-U

Push-in connector (with push-in sleeve)					
Image	D1 (tube)	D2 (tube)	Pkg unit	Part no.	Description
	1/8	1/4	10	564810	QB-1/8H-1/4-U
	5/32	1/8	10	564811	QB-5/32H-1/8-U
	5/32	1/4	10	564812	QB-5/32H-1/4-U
	1/4	1/8	10	564813	QB-1/4H-1/8-U
	1/4	5/32	10	564814	QB-1/4H-5/32-U
	5/16	5/32	10	564815	QB-5/16H-5/32-U
	5/16	1/4	10	564816	QB-5/16H-1/4-U
	3/8	1/4	10	564817	QB-3/8H-1/4-U
	3/8	5/16	10	567779	QB-3/8H-5/16-U
	1/2	3/8	10	567780	QB-1/2H-3/8-U

Push-in L - connector (with push-in sleeve)					
Image	D1 (tube)	D2 (tube)	Pkg unit	Part no.	Description
	1/4	1/4	10	153654	QSL-1/4H-U
	5/16	5/16	1	153655	QSL-5/16H-U
	3/8	3/8	1	153656	QSL-3/8H-U
	1/2	1/2	1	190623	QSL-1/2H-U

Push-in T - connector (reducing)					
Image	D1 (tube)	D2 (tube)	Pkg unit	Part no.	Description
	1/4	5/32	10	564805	QBT-1/4T-5/32-U
	5/16	1/4	10	564806	QBT-5/16T-1/4-U
	3/8	1/4	10	564807	QBT-3/8T-1/4-U
	3/8	5/16	10	564808	QBT-3/8T-5/16-U
	1/2	3/8	5	564809	QBT-1/2T-3/8-U

Push-in bulkhead connector					
Image	D1 (tube)	D2 (tube)	Pkg unit	Part no.	Description
	5/32	5/32	10	564748	QBS-5/32T-U
	1/4	1/4	10	564750	QBS-1/4T-U
	5/16	5/16	10	564751	QBS-5/16T-U
	3/8	3/8	5	564752	QBS-3/8T-U
	1/2	1/2	5	564753	QBS-1/2T-U

Push-in connector					
Image	D1 (tube)	D2 (tube)	Pkg unit	Part no.	Description
	5/32	5/32	10	564754	QB-5/32T-U
	1/4	1/4	10	564756	QB-1/4T-U
	5/16	5/16	10	564757	QB-5/16T-U
	3/8	3/8	10	564758	QB-3/8T-U
	1/2	1/2	5	564759	QB-1/2T-U

Push-in L - connector					
Image	D1 (tube)	D2 (tube)	Pkg unit	Part no.	Description
	5/32	5/32	10	564760	QBL-5/32T-U
	1/4	1/4	10	564762	QBL-1/4T-U
	5/16	5/16	10	564763	QBL-5/16T-U
	3/8	3/8	10	564764	QBL-3/8T-U
	1/2	1/2	5	564765	QBL-1/2T-U

Push-in T - connector					
Image	D1 (tube)	D2 (tube)	Pkg unit	Part no.	Description
	5/32	5/32	10	564766	QBT-5/32T-U
	1/4	1/4	10	564768	QBT-1/4T-U
	5/16	5/16	10	564769	QBT-5/16T-U
	3/8	3/8	5	564770	QBT-3/8T-U
	1/2	1/2	5	564771	QBT-1/2T-U

Push-in Y - connector					
Image	D1 (tube)	D2 (tube)	Pkg unit	Part no.	Description
	5/32	5/32	10	564772	QBY-5/32T-U
	1/4	1/4	10	564774	QBY-1/4T-U
	5/16	5/16	10	564775	QBY-5/16T-U
	3/8	3/8	5	564776	QBY-3/8T-U
	1/2	1/2	5	564777	QBY-1/2T-U

Push-in Y - connector (reducing)					
Image	D1 (tube)	D2 (tube)	Pkg unit	Part no.	Description
	1/4	5/32	10	564819	QBY-1/4T-5/32-U
	5/16	5/32	10	564821	QBY-5/16T-5/32-U
	5/16	1/4	10	564822	QBY-5/16T-1/4-U
	3/8	1/4	10	564823	QBY-3/8T-1/4-U
	3/8	5/16	10	564824	QBY-3/8T-5/16-U
	1/2	5/16	5	564826	QBY-1/2T-5/16-U
	1/2	3/8	5	564825	QBY-1/2T-3/8-U

Blanking plug					
Image	D1 (tube)	D2 (tube)	Pkg unit	Part no.	Description
	-	5/32	10	564784	QBC-5/32H-U
	-	1/4	10	564786	QBC-1/4H-U
	-	5/16	10	564787	QBC-5/16H-U
	-	3/8	10	564788	QBC-3/8H-U
	-	1/2	10	564789	QBC-1/2H-U

Hybrid push-in fittings

QB/QS hybrid mini (ISO --> Inch Tube)

Push-in fitting (with Internal hex)					
Image	D1 (thread)	D2 (tube)	Pkg unit	Part no.	Description
	M3	1/8	10	183751	QSM-M3-1/8-I-U-M
	M3	5/32	1	130592	QSM-M3-5/32-I-U-M
	M5	1/8	10	183749	QSM-M5-1/8-I-U-M
	M5	5/32	10	130593	QSM-M5-5/32-I-U-M
	M5	1/4	50	130591	QSM-M5-1/4-I-U-M
	M7	1/8	10	183738	QSM-M7-1/8-I-U-M
	M7	1/4	50	183740	QSM-M7-1/4-I-U-M

Push-in T - fitting					
Image	D1 (thread)	D2 (tube)	Pkg unit	Part no.	Description
	M5	1/8	10	533247	QBMT-M5-1/8-U-M
	R 1/8	1/8	10	533251	QBMT-1/8-1/8-U-M

Push-in fitting (with Internal hex)					
Image	D1 (thread)	D2 (tube)	Pkg unit	Part no.	Description
	M5	1/4	10	192808	QS-M5-1/4-I-U-M
	R 1/8	1/4	10	183741	QS-1/8-1/4-I-U-M
	R 1/8	5/16	10	183742	QS-1/8-5/16-I-U-M
	R 1/4	1/4	10	192809	QS-1/4-1/4-I-U-M
	R 1/4	5/16	1	183743	QS-1/4-5/16-I-U-M
	R 1/4	3/8	10	183744	QS-1/4-3/8-I-U-M
	R 3/8	5/16	1	183745	QS-3/8-5/16-I-U-M
	R 3/8	3/8	1	183746	QS-3/8-3/8-I-U-M
	R 1/2	3/8	1	183747	QS-1/2-3/8-I-U-M
	R 1/2	1/2	1	183748	QS-1/2-1/2-I-U-M

Push-in fitting (external hex)					
Image	D1 (thread)	D2 (tube)	Pkg unit	Part no.	Description
	M5	5/32	10	533210	QB-M5-5/32-U-M
	M5	1/4	10	533212	QB-M5-1/4-U-M
	R 1/8	5/32	10	533214	QB-1/8-5/32-U-M
	R 1/8	1/4	10	533216	QB-1/8-1/4-U-M
	R 1/8	5/16	10	533217	QB-1/8-5/16-U-M
	R 1/4	1/4	10	533219	QB-1/4-1/4-U-M
	R 1/4	5/16	10	533220	QB-1/4-5/16-U-M
	R 1/4	3/8	10	533221	QB-1/4-3/8-U-M
	R 3/8	1/4	10	533222	QB-3/8-1/4-U-M
	R 3/8	5/16	10	533223	QB-3/8-5/16-U-M
	R 3/8	3/8	5	533224	QB-3/8-3/8-U-M
	R 3/8	1/2	5	533225	QB-3/8-1/2-U-M
	R 1/2	3/8	5	533226	QB-1/2-3/8-U-M
	R 1/2	1/2	5	533227	QB-1/2-1/2-U-M

Push-in fitting (with External hex)					
Image	D1 (thread)	D2 (tube)	Pkg unit	Part no.	Description
	M5	1/8	10	533209	QBM-M5-1/8-U-M
	R 1/8	1/8	10	533213	QBM-1/8-1/8-U-M

Push-in L - fitting					
Image	D1 (thread)	D2 (tube)	Pkg unit	Part no.	Description
	M5	1/8	10	533228	QBML-M5-1/8-U-M
	R 1/8	1/8	10	533232	QBML-1/8-1/8-U-M

Push-in L - fitting					
Image	D1 (thread)	D2 (tube)	Pkg unit	Part no.	Description
	M5	5/32	10	533229	QBL-M5-5/32-U-M
	M5	1/4	10	533231	QBL-M5-1/4-U-M
	R 1/8	5/32	10	533233	QBL-1/8-5/32-U-M
	R 1/8	1/4	10	533235	QBL-1/8-1/4-U-M
	R 1/8	5/16	10	533236	QBL-1/8-5/16-U-M
	R 1/8	3/8	5	562578	QBL-1/8-3/8-U-M
	R 1/4	1/4	10	533238	QBL-1/4-1/4-U-M
	R 1/4	5/16	10	533239	QBL-1/4-5/16-U-M
	R 1/4	3/8	5	533240	QBL-1/4-3/8-U-M
	R 3/8	1/4	5	533241	QBL-3/8-1/4-U-M
	R 3/8	5/16	5	533242	QBL-3/8-5/16-U-M
	R 3/8	3/8	5	533243	QBL-3/8-3/8-U-M
	R 3/8	1/2	5	533244	QBL-3/8-1/2-U-M
	R 1/2	3/8	5	533245	QBL-1/2-3/8-U-M
R 1/2	1/2	5	533227	QB-1/2-1/2-U-M	

Push-in T - fitting					
Image	D1 (thread)	D2 (tube)	Pkg unit	Part no.	Description
	M5	5/32	10	533248	QBT-M5-5/32-U-M
	M5	1/4	10	533250	QBT-M5-1/4-U-M
	R 1/8	5/32	10	533252	QBT-1/8-5/32-U-M
	R 1/8	1/4	10	533254	QBT-1/8-1/4-U-M
	R 1/8	5/16	5	533255	QBT-1/8-5/16-U-M
	R 1/8	3/8	5	562579	QBT-1/8-3/8-U-M
	R 1/4	1/4	5	533257	QBT-1/4-1/4-U-M
	R 1/4	5/16	5	533258	QBT-1/4-5/16-U-M
	R 1/4	3/8	5	533259	QBT-1/4-3/8-U-M
	R 3/8	1/4	5	533260	QBT-3/8-1/4-U-M
	R 3/8	5/16	5	533261	QBT-3/8-5/16-U-M
	R 3/8	3/8	5	533262	QBT-3/8-3/8-U-M
	R 3/8	1/2	1	533263	QBT-3/8-1/2-U-M
	R 1/2	3/8	5	533264	QBT-1/2-3/8-U-M
	R 1/2	1/2	1	533265	QBT-1/2-1/2-U-M



GRLA Inch flow controls (exhaust)

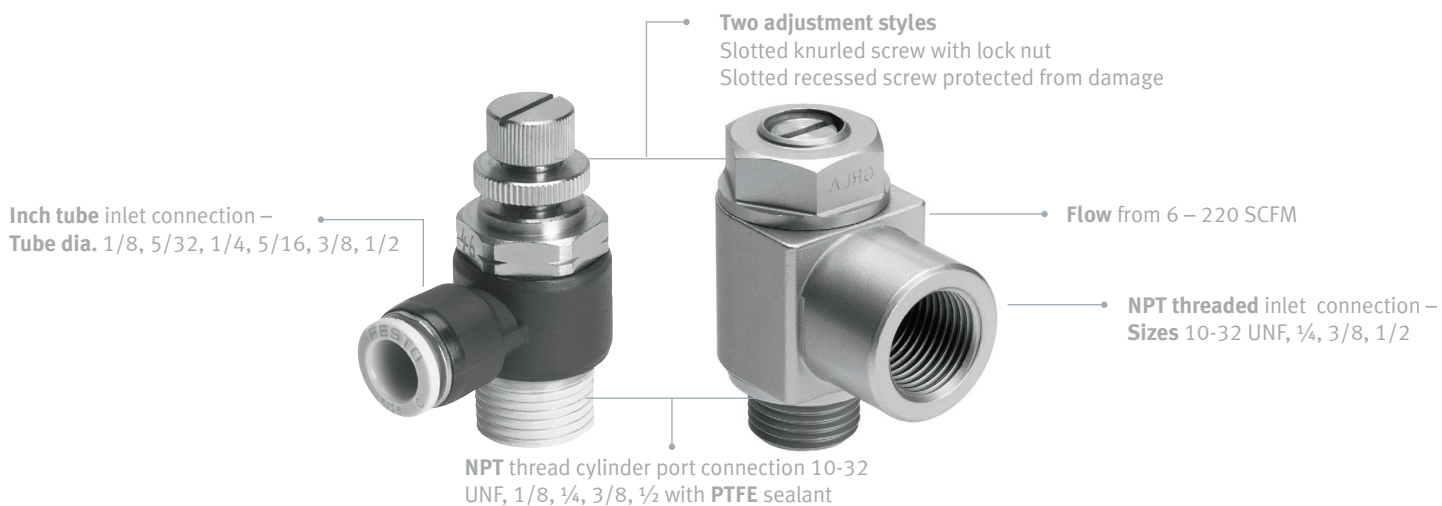

GRLA-B (inch) one way flow control valves

Flow control (Exhaust) - Knurled screw adjustment					
Image	D1 (thread)	D2 (tube)	Pkg unit	Part no.	Description
	10-32 UNF	1/8	1	564839	GRLA-10-32-UNF-QB-1/8-U
	10-32 UNF	5/32	1	564840	GRLA-10-32-UNF-QB-5/32-U
	10-32 UNF	1/4	1	564842	GRLA-10-32-UNF-QB-1/4-U
	1/8 NPT	5/32	1	534656	GRLA-1/8-QB-5/32-U
	1/8 NPT	1/4	1	534658	GRLA-1/8-QB-1/4-U
	1/8 NPT	5/16	1	534659	GRLA-1/8-QB-5/16-U
	1/4 NPT	1/4	1	534661	GRLA-1/4-QB-1/4-U
	1/4 NPT	5/16	1	534662	GRLA-1/4-QB-5/16-U
	1/4 NPT	3/8	1	534663	GRLA-1/4-QB-3/8-U
	3/8 NPT	1/4	1	534664	GRLA-3/8-QB-1/4-U
	3/8 NPT	5/16	1	534665	GRLA-3/8-QB-5/16-U
	3/8 NPT	3/8	1	534666	GRLA-3/8-QB-3/8-U
	3/8 NPT	1/2	1	534667	GRLA-3/8-QB-1/2-U
	1/2 NPT	3/8	1	564846	GRLA-1/2-QB-3/8-U
	1/2 NPT	1/2	1	564847	GRLA-1/2-QB-1/2-U

Flow control (Exhaust) - Recessed slotted screw adjustment					
Image	D1 (thread)	D2 (thread)	Pkg unit	Part no.	Description
	10-32 UNF	10-32 UNF	1	151539	GRLA-1/8-NPT-B
	1/8 NPT	1/8 NPT	1	151547	GRLA-1/4-NPT-B
	1/4 NPT	1/4 NPT	1	151555	GRLA-3/8-NPT-B
	3/8 NPT	3/8 NPT	1	151559	GRLA-1/2-NPT-B
	1/2 NPT	1/2 NPT	1	151572	GRLA-10-UNF-B



QS standard metric push-in fittings and connectors

High strength PBT body with nickel plated threading



POM-release ring for quick and easy tube release

Metric tube connections
4, 6, 8, 10, 12, 16mm





Standard models
Metric M3, M5, M6, M7
ISO-R 1/8, 1/4, 3/8, 1/2
ISO-G 1/8, 1/4, 3/8, 1/2

Thread seal
ISO-R connection – PTFE thread sealant
Metric and ISO-G – Sealing ring

QS standard, mini - push-in fittings

Push-in fitting					
Image	D1 (thread)	D2 (tube)	Pkg unit	Part no.	Description
	M3	4 mm	10	153303	QSM-M3-4
	M5	4 mm	10	153304	QSM-M5-4
	M5	4 mm	100	130778	QSM-M5-4-100
	M5	6 mm	10	153306	QSM-M5-6
	M5	6 mm	100	130779	QSM-M5-6-100
	M6	6 mm	10	132600	QSM-M6-6
	R 1/8	4 mm	10	153305	QSM-1/8-4
	R 1/8	6 mm	10	153307	QSM-1/8-6
	G 1/8	4 mm	10	186264	QSM-G1/8-4
	G 1/8	6 mm	10	186265	QSM-G1/8-6

Push-in fitting (with internal hex & oval release ring)					
Image	D1 (thread)	D2 (tube)	Pkg unit	Part no.	Description
	M3	4 mm	10	153314	QSM-M3-4-I
	M5	4 mm	10	153315	QSM-M5-4-I
	M5	6 mm	10	153317	QSM-M5-6-I
	M7	4 mm	10	153319	QSM-M7-4-I
	M7	4 mm	100	133006	QSM-M7-4-I-100
	M7	6 mm	10	153321	QSM-M7-6-I
	R 1/8	4 mm	10	153316	QSM-1/8-4-I
	R 1/8	6 mm	10	153318	QSM-1/8-6-I
	G 1/8	4 mm	10	186266	QSM-G1/8-4-I
	G 1/8	6 mm	10	186267	QSM-G1/8-6-I

Push-in fitting (with internal hex & oval release ring)					
Image	D1 (thread)	D2 (tube)	Pkg unit	Part no.	Description
	M3	4 mm	10	133002	QSM-M3-4-I-R
	M5	4 mm	10	133004	QSM-M5-4-I-R
	M5	4 mm	100	132917	QSM-M5-4-I-R-100
	M5	6 mm	10	133005	QSM-M5-6-I-R
	M5	6 mm	100	132918	QSM-M5-6-I-R-100
	M7	6 mm	10	133007	QSM-M7-6-I-R
	M7	6 mm	100	132919	QSM-M7-6-I-R-100

Push-in fitting (with internal hex & oval release ring)					
Image	D1 (thread)	D2 (tube)	Pkg unit	Part no.	Description
	M3	4 mm	10	153332	QSML-M3-4
	M5	4 mm	10	153333	QSML-M5-4
	M5	4 mm	100	130771	QSML-M5-4-100
	M5	6 mm	10	153335	QSML-M5-6
	M5	6 mm	100	130772	QSML-M5-6-100
	M7	4 mm	10	186352	QSML-M7-4
	M7	6 mm	10	186353	QSML-M7-6
	R 1/8	4 mm	10	153334	QSML-1/8-4
	R 1/8	6 mm	10	153336	QSML-1/8-6
	G 1/8	4 mm	10	186268	QSML-G1/8-4
G 1/8	6 mm	10	186269	QSML-G1/8-6	

Push-in T-fitting					
Image	D1 (thread)	D2 (tube)	Pkg unit	Part no.	Description
	M3	4 mm	10	153353	QSMT-M3-4
	M5	4 mm	10	153354	QSMT-M5-4
	M5	6 mm	10	153356	QSMT-M5-6
	1/8	4 mm	10	153355	QSMT-1/8-4
	1/8	6 mm	10	153357	QSMT-1/8-6

Push-in L-fitting (internal Hex)					
Image	D1 (thread)	D2 (tube)	Pkg unit	Part no.	Description
	M5	4 mm	10	130831	QSMLV-M5-4-I
	M7	4 mm	10	130832	QSMLV-M7-4-I
	M7	6 mm	10	130833	QSMLV-M7-6-I







QS standard - push-in fittings

Push-in fitting (external hex)					
Image	D1 (thread)	D2 (tube)	Pkg unit	Part no.	Description
	G 1/8	4 mm	10	186095	QS-G1/8-4
	G 1/8	6 mm	10	186096	QS-G1/8-6
	G 1/8	6 mm	100	132037	QS-G1/8-6-100
	G 1/8	8 mm	10	186098	QS-G1/8-8
	G 1/8	8 mm	50	132038	QS-G1/8-8-50
	G 1/4	6 mm	10	186097	QS-G1/4-6
	G 1/4	6 mm	100	132039	QS-G1/4-6-100
	G 1/4	8 mm	10	186099	QS-G1/4-8
	G 1/4	8 mm	50	132040	QS-G1/4-8-50
	G 1/4	10 mm	10	186101	QS-G1/4-10
	G 1/4	10 mm	50	132041	QS-G1/4-10-50
	G 1/4	12 mm	10	186350	QS-G1/4-12
	G 3/8	8 mm	10	186100	QS-G3/8-8
	G 3/8	10 mm	10	186102	QS-G3/8-10
	G 3/8	12 mm	10	186103	QS-G3/8-12
	G 1/2	12 mm	1	186104	QS-G1/2-12
G 1/2	16 mm	1	186105	QS-G1/2-16	

Push-in fitting (Internal hex)					
Image	D1 (thread)	D2 (tube)	Pkg unit	Part no.	Description
	R 1/8	4 mm	10	153012	QS-1/8-4-I
	R 1/8	6 mm	10	153013	QS-1/8-6-I
	R 1/8	8 mm	10	153015	QS-1/8-8-I
	R 1/8	10 mm	10	190647	QS-1/8-10-I
	R 1/4	6 mm	10	153014	QS-1/4-6-I
	R 1/4	8 mm	10	153016	QS-1/4-8-I
	R 1/4	10 mm	10	153018	QS-1/4-10-I
	R 1/4	12 mm	10	190649	QS-1/4-12-I
	R 3/8	8 mm	10	153017	QS-3/8-8-I
	R 3/8	10 mm	10	153019	QS-3/8-10-I
	R 3/8	12 mm	10	153020	QS-3/8-12-I
	R 1/2	10 mm	1	190648	QS-1/2-10-I
	R 1/2	12 mm	1	153021	QS-1/2-12-I

Push-in L-fitting with female thread					
Image	D1 (thread)	D2 (tube)	Pkg unit	Part no.	Description
	G 1/8	4 mm	10	153273	QSLF-1/8-4-B
	G 1/8	6 mm	10	153274	QSLF-1/8-6-B
	G 1/8	8 mm	10	153276	QSLF-1/8-8-B
	G 1/4	6 mm	10	153275	QSLF-1/4-6-B
	G 1/4	8 mm	10	153277	QSLF-1/4-8-B
	G 1/4	10 mm	10	153279	QSLF-1/4-10-B
	G 3/8	8 mm	10	153278	QSLF-3/8-8-B
	G 3/8	10 mm	10	153280	QSLF-3/8-10-B

Push-in fitting (Internal hex)					
Image	D1 (thread)	D2 (tube)	Pkg unit	Part no.	Description
	G 1/8	4 mm	10	186106	QS-G1/8-4-I
	G 1/8	6 mm	10	186107	QS-G1/8-6-I
	G 1/8	8 mm	10	186109	QS-G1/8-8-I
	G 1/8	10 mm	10	132999	QS-G1/8-10-I
	G 1/4	6 mm	10	186108	QS-G1/4-6-I
	G 1/4	8 mm	10	186110	QS-G1/4-8-I
	G 1/4	10 mm	10	186112	QS-G1/4-10-I
	G 3/8	8 mm	10	186111	QS-G3/8-8-I
	G 3/8	10 mm	10	186113	QS-G3/8-10-I
	G 3/8	12 mm	10	186114	QS-G3/8-12-I
	G 1/2	12 mm	1	186115	QS-G1/2-12-I

Push-in fitting (external hex)					
Image	D1 (thread)	D2 (tube)	Pkg unit	Part no.	Description
  	R 1/8	4 mm	10	153001	QS-1/8-4
	R 1/8	4 mm	100	130674	QS-1/8-4-100
	R 1/8	6 mm	10	153002	QS-1/8-6
	R 1/8	6 mm	100	130675	QS-1/8-6-100
	R 1/8	8 mm	10	153004	QS-1/8-8
	R 1/8	8 mm	50	130676	QS-1/8-8-50
	R 1/8	10 mm	10	190643	QS-1/8-10
	R 1/4	4 mm	10	190644	QS-1/4-4
	R 1/4	6 mm	10	153003	QS-1/4-6
	R 1/4	6 mm	100	130677	QS-1/4-6-100
	R 1/4	8 mm	10	153005	QS-1/4-8
	R 1/4	8 mm	50	130678	QS-1/4-8-50
	R 1/4	10 mm	10	153007	QS-1/4-10
	R 1/4	10 mm	50	130679	QS-1/4-10-50
	R 1/4	12 mm	10	164980	QS-1/4-12
	R 1/4	12 mm	20	130680	QS-1/4-12-20
	R 3/8	6 mm	10	190645	QS-3/8-6
	R 3/8	8 mm	10	153006	QS-3/8-8
	R 3/8	8 mm	50	130681	QS-3/8-8-50
	R 3/8	10 mm	10	153008	QS-3/8-10
	R 3/8	10 mm	50	130682	QS-3/8-10-50
	R 3/8	12 mm	10	153009	QS-3/8-12
	R 3/8	12 mm	20	130683	QS-3/8-12-20
	R 3/8	16 mm	1	164957	QS-3/8-16
	R 1/2	10 mm	1	190646	QS-1/2-10
	R 1/2	10 mm	50	133189	QS-1/2-10-50
	R 1/2	12 mm	1	153010	QS-1/2-12
	R 1/2	12 mm	20	130684	QS-1/2-12-20
	R 1/2	16 mm	1	153011	QS-1/2-16
	R 1/2	16 mm	20	130685	QS-1/2-16-20



Push-in L-fitting					
Image	D1 (thread)	D2 (tube)	Pkg unit	Part no.	Description
	R 1/8	4 mm	10	153045	QSL-1/8-4
	R 1/8	4 mm	100	130728	QSL-1/8-4-100
	R 1/8	6 mm	10	153046	QSL-1/8-6
	R 1/8	6 mm	100	130729	QSL-1/8-6-100
	R 1/8	8 mm	10	153048	QSL-1/8-8
	R 1/8	8 mm	50	130730	QSL-1/8-8-50
	R 1/8	10 mm	10	190658	QSL-1/8-10
	R 1/4	4 mm	10	190659	QSL-1/4-4
	R 1/4	6 mm	10	153047	QSL-1/4-6
	R 1/4	6 mm	100	130731	QSL-1/4-6-100
	R 1/4	8 mm	10	153049	QSL-1/4-8
	R 1/4	8 mm	50	130732	QSL-1/4-8-50
	R 1/4	10 mm	10	153051	QSL-1/4-10
	R 1/4	10 mm	50	130733	QSL-1/4-10-50
	R 1/4	12 mm	10	164981	QSL-1/4-12
	R 3/8	6 mm	10	190660	QSL-3/8-6
	R 3/8	8 mm	10	153050	QSL-3/8-8
	R 3/8	10 mm	10	153052	QSL-3/8-10
	R 3/8	12 mm	10	153053	QSL-3/8-12
	R 3/8	16 mm	1	164958	QSL-3/8-16
R 1/2	10 mm	1	190661	QSL-1/2-10	
R 1/2	12 mm	1	153054	QSL-1/2-12	
R 1/2	16 mm	1	153055	QSL-1/2-16	

Push-in L-fitting					
Image	D1 (thread)	D2 (tube)	Pkg unit	Part no.	Description
	G 1/8	4 mm	10	186116	QSL-G1/18-4
	G 1/8	4 mm	100	132048	QSL-G1/8-4-100
	G 1/8	6 mm	10	186117	QSL-G1/18-6
	G 1/8	6 mm	100	132049	QSL-G1/8-6-100
	G 1/8	8 mm	10	186119	QSL-G1/18-8
	G 1/8	8 mm	50	132050	QSL-G1/8-8-50
	G 1/4	6 mm	10	186118	QSL-G1/4-6
	G 1/4	6 mm	100	132051	QSL-G1/4-6-100
	G 1/4	8 mm	10	186120	QSL-G1/4-8
	G 1/4	8 mm	50	132052	QSL-G1/4-8-50
	G 1/4	10 mm	10	186122	QSL-G1/4-10
	G 1/4	10 mm	50	132053	QSL-G1/4-10-50
	G 1/4	12 mm	10	186351	QSL-G1/4-12
	G 3/8	8 mm	10	186121	QSL-G3/18-8
	G 3/8	10 mm	10	186123	QSL-G3/18-10
	G 3/8	12 mm	10	186124	QSL-G3/18-12
	G 1/2	12 mm	1	186125	QSL-G1/2-12
	G 1/2	16 mm	1	186126	QSL-G1/2-16

Push-in fitting with female thread					
Image	D1 (thread)	D2 (tube)	Pkg unit	Part no.	Description
	G 1/8	4 mm	10	153022	QSF-1/8-4-B
	G 1/8	8 mm	10	153025	QSF-1/8-8-B
	G 1/8	6 mm	10	153023	QSF-1/8-6-B
	G 1/4	4 mm	10	190650	QSF-1/4-4-B
	G 1/4	6 mm	10	153024	QSF-1/4-6-B
	G 1/4	8 mm	10	153026	QSF-1/4-8-B
	G 1/4	10 mm	10	153028	QSF-1/4-10-B
	G 1/4	12 mm	10	190651	QSF-1/4-12-B
	G 3/8	6 mm	10	190652	QSF-3/8-6-B
	G 3/8	8 mm	10	153027	QSF-3/8-8-B
	G 3/8	10 mm	10	153029	QSF-3/8-10-B
	G 3/8	12 mm	10	153030	QSF-3/8-12-B
	G 1/2	12 mm	1	190653	QSF-1/2-12-B
	G 1/2	16 mm	1	190654	QSF-1/2-16-B

Push-in long L-fitting					
Image	D1 (thread)	D2 (tube)	Pkg unit	Part no.	Description
	R 1/8	4 mm	10	153076	QSL-1/8-4
	R 1/8	6 mm	10	153077	QSL-1/8-6
	R 1/8	8 mm	10	153079	QSL-1/8-8
	R 1/4	4 mm	10	190662	QSL-1/4-4
	R 1/4	6 mm	10	153078	QSL-1/4-6
	R 1/4	8 mm	10	153080	QSL-1/4-8
	R 1/4	10 mm	10	153082	QSL-1/4-10
	R 3/8	6 mm	10	190663	QSL-3/8-6
	R 3/8	8 mm	10	153081	QSL-3/8-8
	R 3/8	10 mm	10	153083	QSL-3/8-10
	R 3/8	12 mm	10	153084	QSL-3/8-12
	R 1/2	12 mm	1	153085	QSL-1/2-12
	R 1/2	10 mm	1	190664	QSL-1/2-10

Push-in fitting (external hex)					
Image	D1 (thread)	D2 (tube)	Pkg unit	Part no.	Description
	M5	6 mm	10	190666	QSLV-M5-6
	R 1/8	4 mm	10	153086	QSLV-1/8-4
	R 1/8	6 mm	10	153087	QSLV-1/8-6
	R 1/8	8 mm	10	153089	QSLV-1/8-8
	R 1/4	6 mm	10	153088	QSLV-1/4-6
	R 1/4	8 mm	10	153090	QSLV-1/4-8
	R 1/4	10 mm	10	153092	QSLV-1/4-10
	R 3/8	8 mm	10	153091	QSLV-3/8-8
	R 3/8	10 mm	10	153093	QSLV-3/8-10
	R 3/8	12 mm	10	153094	QSLV-3/8-12
	R 1/2	12 mm	1	153095	QSLV-1/2-12
	R 1/2	16 mm	1	153096	QSLV-1/2-16





Push-in long L-fitting					
Image	D1 (thread)	D2 (tube)	Pkg unit	Part no.	Description
	G 1/8	4mm	10	186127	QSSL-G1/8-4
	G 1/8	6 mm	10	186128	QSSL-G1/8-6
	G 1/8	8 mm	10	186130	QSSL-G1/8-8
	G 1/4	6mm	10	186129	QSSL-G1/4-6
	G 1/4	8 mm	10	186131	QSSL-G1/4-8
	G 1/4	10mm	10	186133	QSSL-G1/4-10

Push-in T-fitting					
Image	D1 (thread)	D2 (tube)	Pkg unit	Part no.	Description
	R 1/8	4 mm	10	153106	QST-1/8-4
	R 1/8	6 mm	10	153107	QST-1/8-6
	R 1/8	8 mm	10	153109	QST-1/8-8
	R 1/8	10 mm	10	190667	QST-1/8-10
	R 1/4	4 mm	10	190668	QST-1/4-4
	R 1/4	6 mm	10	153108	QST-1/4-6
	R 1/4	8 mm	10	153110	QST-1/4-8
	R 1/4	10 mm	10	153112	QST-1/4-10
	R 1/4	12 mm	10	190669	QST-1/4-12
	R 3/8	6 mm	10	190670	QST-3/8-6
	R 3/8	8 mm	10	153111	QST-3/8-8
	R 3/8	10 mm	10	153113	QST-3/8-10
	R 3/8	12 mm	10	153114	QST-3/8-12
	R 1/2	10 mm	1	190672	QST-1/2-10
	R 1/2	12 mm	1	153115	QST-1/2-12
	R 1/2	16 mm	1	153116	QST-1/2-16

Push-in Y-fitting					
Image	D1 (thread)	D2 (tube)	Pkg unit	Part no.	Description
	M5	4 mm	10	190673	QSY-M5-4
	M5	6 mm	10	190674	QSY-M5-6
	R 1/8	4 mm	10	153138	QSY-1/8-4
	R 1/8	6 mm	10	153139	QSY-1/8-6
	R 1/8	8 mm	10	153141	QSY-1/8-8
	R 1/4	4 mm	10	190675	QSY-1/4-4
	R 1/4	6 mm	10	153140	QSY-1/4-6
	R 1/4	8 mm	10	153142	QSY-1/4-8
	R 1/4	10 mm	10	153144	QSY-1/4-10
	R 3/8	8 mm	10	153143	QSY-3/8-8
	R 3/8	10 mm	10	153145	QSY-3/8-10
	R 3/8	12 mm	10	153146	QSY-3/8-12
	R 1/2	12 mm	1	153147	QSY-1/2-12

Push-in fitting (external hex)					
Image	D1 (thread)	D2 (tube)	Pkg unit	Part no.	Description
	G 1/8	4 mm	10	186137	QSLV-G1/8-4
	G 1/8	6 mm	10	186138	QSLV-G1/8-6
	G 1/8	8 mm	10	186140	QSLV-G1/8-8
	G 1/4	6 mm	10	186139	QSLV-G1/4-6
	G 1/4	8 mm	10	186141	QSLV-G1/4-8
	G 1/4	10 mm	10	186143	QSLV-G1/4-10
	G 3/8	8 mm	10	186142	QSLV-G3/8-8
	G 3/8	10 mm	10	186144	QSLV-G3/8-10
	G 3/8	12 mm	10	186145	QSLV-G3/8-12
	G 1/2	12 mm	1	186146	QSLV-G1/2-12
	G 1/2	16 mm	1	186147	QSLV-G1/2-16

Push-in T-fitting					
Image	D1 (thread)	D2 (tube)	Pkg unit	Part no.	Description
	R 1/8	4 mm	10	153117	QSTL-1/8-4
	R 1/8	6 mm	10	153118	QSTL-1/8-6
	R 1/8	8 mm	10	153120	QSTL-1/8-8
	R 1/4	6 mm	10	153119	QSTL-1/4-6
	R 1/4	8 mm	10	153121	QSTL-1/4-8
	R 1/4	10 mm	10	153123	QSTL-1/4-12
	R 3/8	8 mm	10	153122	QSTL-3/8-8
	R 3/8	10 mm	10	153124	QSTL-3/8-10
	R 3/8	12 mm	10	153125	QSTL-3/8-12
	R 1/2	12 mm	1	153126	QSTL-1/2-12
	R 1/2	16 mm	1	153127	QSTL-1/2-16

Bulkhead Push-in fitting					
Image	D1 (thread)	D2 (tube)	Pkg unit	Part no.	Description
	R 1/8	4 mm	10	153162	QSSF-1/8-4-B
	R 1/8	6 mm	10	153163	QSSF-1/8-6-B
	R 1/8	8 mm	10	153165	QSSF-1/8-8-B
	R 1/4	4 mm	10	190655	QSSF-1/4-4-B
	R 1/4	6 mm	10	153164	QSSF-1/4-6-B
	R 1/4	8 mm	10	153166	QSSF-1/4-8-B
	R 1/4	10 mm	10	153168	QSSF-1/4-10-B
	R 3/8	6 mm	10	190656	QSSF-3/8-6-B
	R 3/8	8 mm	10	153167	QSSF-3/8-8-B
	R 3/8	10 mm	10	153169	QSSF-3/8-10-B
	R 3/8	12 mm	10	153170	QSSF-3/8-12-B
	R 1/2	12 mm	1	153171	QSSF-1/2-12-B
	R 1/2	16 mm	1	190657	QSSF-1/2-16-B

QS standard push-in connectors

QS standard, mini - connectors					
Image	D1 (tube)	D2 (tube)	Pkg unit	Part no.	Description
	4 mm	4 mm	10	153324	QSM-4
	6 mm	6 mm	10	153325	QSM-6
Push-in connector with push-in sleeve					
	6 mm	4 mm	10	153329	QSM-6H-4
Push-in connector (reducing)					
	6 mm	4 mm	10	153327	QSM-6-4
Push-in L-connector					
	4 mm	4 mm	10	153344	QSML-4
	6 mm	6 mm	10	153345	QSML-6
Push-in L-connector with long push-in sleeve					
	4 mm	4 mm	10	153347	QSML-4H
	6 mm	6 mm	10	153348	QSML-6H
Push-in L-connector with long push-in sleeve (reducing)					
	6 mm	4 mm	10	153350	QSML-6H-4
Push-in T-connector					
	4 mm	4 mm	10	153366	QSMT-4
	6 mm	6 mm	10	153367	QSMT-6
Push-in T-connector (reducing)					
	6 mm	4 mm	10	153369	QSMT-6-4
Push-in Y-connector					
	4 mm	4 mm	10	153371	QSMY-4
	6 mm	6 mm	10	153372	QSMY-6
Push-in Y-connector (reducing)					
	6 mm	4 mm	10	153374	QSMY-6-4
Push-in connector (self-sealing)					
	4 mm	4 mm	1	153439	QSMK-4
	6 mm	6 mm	1	153440	QSMK-6
Push-in bulkhead connector					
	4 mm	4 mm	10	153376	QSMS-4
	6 mm	6 mm	10	153377	QSMS-6



QS standard - connectors

Push-in connector					
Image	D1 (thread)	D2 (tube)	Pkg unit	Part no.	Description
	4 mm	4 mm	10	153031	QS-4
	4 mm	4 mm	100	130686	QS-4-100
	6 mm	6 mm	10	153032	QS-6
	6 mm	6 mm	100	130687	QS-6-100
	8 mm	8 mm	10	153033	QS-8
	8 mm	8 mm	50	130688	QS-8-50
	10 mm	10 mm	10	153034	QS-10
	10 mm	10 mm	50	130689	QS-10-50
	12 mm	12 mm	10	153035	QS-12
	12 mm	20 mm	20	130690	QS-12-20
	16 mm	16 mm	1	153036	QS-16

Push-in connector (reducing)					
Image	D1 (tube)	D2 (tube)	Pkg unit	Part no.	Description
	6 mm	4 mm	10	153037	QS-6-4
	6 mm	4 mm	100	130691	QS-6-4-100
	8 mm	4 mm	10	130606	QS-8-4
	8 mm	6 mm	10	153038	QS-8-6
	8 mm	6 mm	50	130692	QS-8-6-50
	10 mm	6 mm	10	130607	QS-10-6
	10 mm	8 mm	10	153039	QS-10-8
	10 mm	8 mm	50	130693	QS-10-8-50
	12 mm	8 mm	10	130608	QS-12-8
	12 mm	10 mm	10	153040	QS-12-10

Push-in connector with push-in sleeve					
Image	D1 (tube)	D2 (tube)	Pkg unit	Part no.	Description
	6 mm	4 mm	10	153041	QS-6H-4
	6 mm	4 mm	100	130695	QS-6H-4-100
	8 mm	4 mm	10	130622	QS-8H-4
	8 mm	6 mm	10	153042	QS-8H-6
	8 mm	6 mm	50	130696	QS-8H-6-50
	10 mm	6 mm	10	130623	QS-10H-6
	10 mm	8 mm	10	153043	QS-10H-8
	12 mm	10 mm	10	153044	QS-12H-10
	12 mm	6 mm	10	132981	QS-12H-6
	12 mm	8 mm	10	130624	QS-12H-8

Push-in sleeve					
Image	D1 (tube)	D2 (tube)	Pkg unit	Part no.	Description
	4 mm	4 mm	10	153251	QSH-4
	6 mm	6 mm	10	153252	QSH-6
	8 mm	8 mm	10	153253	QSH-8
	10 mm	10 mm	10	153254	QSH-10
	12 mm	12 mm	10	153255	QSH-12
	16 mm	16 mm	1	153256	QSH-16

Push-in sleeve (Reducing)					
Image	D1 (tube)	D2 (tube)	Pkg unit	Part no.	Description
	6 mm	4 mm	10	153257	QSH-6-4
	8 mm	6 mm	10	153258	QSH-8-6
	10 mm	8 mm	10	153259	QSH-10-8
	12 mm	10 mm	10	153260	QSH-12-10
	12 mm	12 mm	10	153261	QSH-16-12

Push-in L-connector					
Image	D1 (tube)	D2 (tube)	Pkg unit	Part no.	Description
	4 mm	4 mm	10	153070	QSL-4
	6 mm	6 mm	10	153071	QSL-6
	8 mm	8 mm	10	153072	QSL-8
	10 mm	10 mm	10	153073	QSL-10
	12 mm	12 mm	10	153074	QSL-12
	16 mm	16 mm	1	153075	QSL-16

Push-in L connector (with push-in sleeve)					
Image	D1 (tube)	D2 (tube)	Pkg unit	Part no.	Description
	4 mm	4 mm	10	153056	QSL-4H
	6 mm	6 mm	10	153057	QSL-6H
	8 mm	8 mm	10	153058	QSL-8H
	10 mm	10 mm	10	153059	QSL-10H
	12 mm	12 mm	10	153060	QSL-12H

Push-in L connector (with push-in sleeve - reducing)					
Image	D1 (tube)	D2 (tube)	Pkg unit	Part no.	Description
	6 mm	4 mm	10	153061	QSL-6H-4
	8 mm	6 mm	10	153062	QSL-8H-6
	10 mm	8 mm	10	153063	QSL-10H-8
	12 mm	10 mm	10	153064	QSL-12H-10

Push-in L connector (with long push-in sleeve)					
Image	D1 (tube)	D2 (tube)	Pkg unit	Part no.	Description
	4 mm	4 mm	10	153065	QSL-4HL
	6 mm	6 mm	10	153066	QSL-6HL
	8 mm	8 mm	10	153067	QSL-8HL
	10 mm	10 mm	10	153068	QSL-10HL
	12 mm	12 mm	10	153069	QSL-12HL

Push-in T-connector					
Image	D1 (tube)	D2 (tube)	Pkg unit	Part no.	Description
	4 mm	4 mm	10	153128	QST-4
	4 mm	4 mm	100	130802	QST-4-100
	6 mm	6 mm	10	153129	QST-6
	6 mm	6 mm	100	130803	QST-6-100
	8 mm	8 mm	10	153130	QST-8
	8 mm	8 mm	50	130804	QST-8-50
	10 mm	10 mm	10	153131	QST-10
	10 mm	10 mm	50	130805	QST-10-50
	12 mm	12 mm	10	153132	QST-12
	16 mm	16 mm	1	153133	QST-16

Push-in T-connector (reducing)					
Image	D1 (tube)	D2 (tube)	Pkg unit	Part no.	Description
	6 mm	4 mm	10	153134	QST-6-4
	6 mm	4 mm	100	130820	QST-6-4-100
	8 mm	4 mm	10	130613	QST-8-4
	8 mm	6 mm	10	153135	QST-8-6
	10 mm	6 mm	10	130614	QST-10-6
	10 mm	8 mm	10	153136	QST-10-8
	12 mm	8 mm	10	130615	QST-12-8
	12 mm	10 mm	10	153137	QST-12-10
	16 mm	12 mm	1	130616	QST-16-12

Push-in Y-connector (reducing)					
Image	D1 (tube)	D2 (tube)	Pkg unit	Part no.	Description
	6 mm	4 mm	10	153153	QSY-6-4
	8 mm	4 mm	10	130610	QSY-8-4
	8 mm	6 mm	10	153154	QSY-8-6
	10 mm	6 mm	10	130611	QSY-10-6
	10 mm	8 mm	10	153155	QSY-10-8
	12 mm	8 mm	10	130612	QSY-12-8
	12 mm	10 mm	10	153156	QSY-12-10
	16 mm	12 mm	1	190708	QSY-16-12
	16 mm	16 mm	1	130609	QSY-16

Push-in Y-connector					
Image	D1 (tube)	D2 (tube)	Pkg unit	Part no.	Description
	4 mm	4 mm	10	153148	QSY-4
	4 mm	4 mm	100	130807	QSY-4-100
	6 mm	6 mm	10	153149	QSY-6
	6 mm	6 mm	100	130808	QSY-6-100
	8 mm	8 mm	10	153150	QSY-8
	8 mm	8 mm	50	130809	QSY-8-50
	10 mm	10 mm	10	153151	QSY-10
	10 mm	10 mm	20	130810	QSY-10-20
	12 mm	12 mm	10	153152	QSY-12

Push-in X-connector					
Image	D1 (tube)	D2 (tube)	Pkg unit	Part no.	Description
	8mm	8mm	10	153285	QSX-8
	10mm	10mm	10	153286	QSX-10
	12mm	12mm	10	153287	QSX-12

Push-in Multi-distributor (Reducing)					
Image	D1 (tube)	D2 (tube)	Pkg unit	Part no.	Description
	6 mm	4 mm	10	153203	QST3-6-4
	8 mm	6 mm	10	153204	QST3-8-6
	10 mm	8 mm	10	153205	QST3-10-8

Push-in bulkhead connector					
Image	D1 (tube)	D2 (tube)	Pkg unit	Part no.	Description
	4 mm	4 mm	10	153157	QSS-4
	6 mm	6 mm	10	153158	QSS-6
	8 mm	8 mm	10	153159	QSS-8
	10 mm	10 mm	10	153160	QSS-10
	12 mm	12 mm	10	153161	QSS-12

Push-in bulkhead connector with fixed collar					
Image	D1 (tube)	D2 (tube)	Pkg unit	Part no.	Description
	8 mm	8 mm	10	130642	QSS-8-F
	10 mm	10 mm	10	130643	QSS-10-F
	12 mm	12 mm	10	130644	QSS-12-F

Push-in cap					
Image	D1 (thread)	D2 (tube)	Pkg unit	Part no.	Description
	-	4 mm	10	153262	QSC-4
	-	6 mm	10	153263	QSC-6
	-	8 mm	10	153264	QSC-8
	-	10 mm	10	153265	QSC-10
	-	12 mm	10	153266	QSC-12

Blanking plug					
Image	D1 (thread)	D2 (tube)	Pkg unit	Part no.	Description
	-	4 mm	10	153267	QSC-4H
	-	4 mm	100	130699	QSC-4H-100
	-	6 mm	10	153268	QSC-6H
	-	6 mm	100	130700	QSC-6H-100
	-	8 mm	10	153269	QSC-8H
	-	8 mm	50	130701	QSC-8H-50
	-	10 mm	10	153270	QSC-10H
	-	10 mm	50	130702	QSC-10H-50
	-	12 mm	10	153271	QSC-12H
	-	12 mm	20	130703	QSC-12H-20
	-	16mm	1	153272	QSC-16H

NPQH metal push-in fittings

Standard models
Metric M5, M7
ISO-G 1/8, 1/4, 3/8, 1/2



Chemically nickel plated
Body & release ring offers excellent corrosion resistance and is suitable for food use. NSF Certified



Metric tube connections in
4, 6, 8, 10, 12 & 14mm

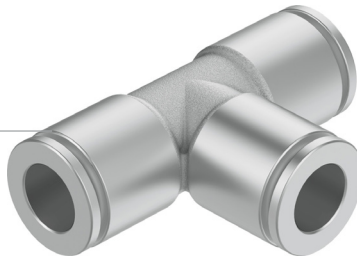

FPM thread & tube seal protects against harsh chemical, oils and elevated temperatures

NPQH Standard - push-in fittings

Push-in fitting (external hex)					
Image	D1 (thread)	D2 (tube)	Pkg unit	Part no.	Description
	M5	4 mm	10	578334	NPQH-D-M5-Q4-P10
	M5	6 mm	10	578335	NPQH-D-M5-Q6-P10
	M7	4 mm	10	578336	NPQH-D-M7-Q4-P10
	M7	6 mm	10	578337	NPQH-D-M7-Q6-P10
	G1/8	4 mm	10	578338	NPQH-D-G18-Q4-P10
	G1/8	6 mm	10	578339	NPQH-D-G18-Q6-P10
	G1/8	8 mm	10	578340	NPQH-D-G18-Q8-P10
	G 1/4	6 mm	10	578341	NPQH-D-G14-Q6-P10
	G 1/4	8 mm	10	578342	NPQH-D-G14-Q8-P10
	G 1/4	10 mm	10	578343	NPQH-D-G14-Q10-P10
	G 1/4	12 mm	10	578344	NPQH-D-G14-Q12-P10
	G 3/8	8 mm	10	578345	NPQH-D-G38-Q8-P10
	G 3/8	10 mm	10	578346	NPQH-D-G38-Q10-P10
	G 3/8	12 mm	10	578347	NPQH-D-G38-Q12-P10
	G 3/8	14 mm	10	578348	NPQH-D-G38-Q14-P10
	G 1/2	10 mm	10	578349	NPQH-D-G12-Q10-P10
	G 1/2	12 mm	10	578350	NPQH-D-G12-Q12-P10
	G 1/2	14 mm	10	578351	NPQH-D-G12-Q14-P10

Push-in L-fitting					
Image	D1 (thread)	D2 (tube)	Pkg unit	Part no.	Description
	M5	4 mm	10	578276	NPQH-L-M5-Q4-P10
	M5	6 mm	10	578277	NPQH-L-M5-Q6-P10
	M7	4 mm	10	578278	NPQH-L-M7-Q4-P10
	M7	6 mm	10	578279	NPQH-L-M7-Q6-P10
	G1/8	4 mm	10	578280	NPQH-L-G18-Q4-P10
	G1/8	6 mm	10	578281	NPQH-L-G18-Q6-P10
	G1/8	8 mm	10	578282	NPQH-L-G18-Q8-P10
	G 1/4	6 mm	10	578283	NPQH-L-G14-Q6-P10
	G 1/4	8 mm	10	578284	NPQH-L-G14-Q8-P10
	G 1/4	10 mm	10	578285	NPQH-L-G14-Q10-P10
	G 1/4	12 mm	10	578286	NPQH-L-G14-Q12-P10
	G 3/8	8 mm	10	578287	NPQH-L-G38-Q8-P10
	G 3/8	10 mm	10	578288	NPQH-L-G38-Q10-P10
	G 3/8	12 mm	10	578289	NPQH-L-G38-Q12-P10
	G 3/8	14 mm	10	578290	NPQH-L-G38-Q14-P10
	G 1/2	10 mm	10	578291	NPQH-L-G12-Q10-P10
	G 1/2	12 mm	10	578292	NPQH-L-G12-Q12-P10
	G 1/2	14 mm	10	578293	NPQH-L-G12-Q14-P10



Push-in T-connector					
Image	D1 (tube)	D2 (tube)	Pkg unit	Part no.	Description
	4 mm	4 mm	10	578380	NPQH-T-Q4-E-P10
	6 mm	6 mm	10	578381	NPQH-T-Q6-E-P10
	8 mm	8 mm	10	578382	NPQH-T-Q8-E-P10
	10 mm	10 mm	10	578383	NPQH-T-Q10-E-P10
	12 mm	12 mm	10	578384	NPQH-T-Q12-E-P10
	14 mm	14 mm	10	578385	NPQH-T-Q14-E-P10

Push-in bulkhead connector					
Image	D1 (tube)	D2 (tube)	Pkg unit	Part no.	Description
	4 mm	4 mm	10	578299	NPQH-H-Q4-E-P10
	6 mm	6 mm	10	578300	NPQH-H-Q6-E-P10
	8 mm	8 mm	10	578301	NPQH-H-Q8-E-P10
	10 mm	10 mm	10	578302	NPQH-H-Q10-E-P10
	12 mm	12 mm	10	578303	NPQH-H-Q12-E-P10

Blanking screw					
Image	D1 (thread)	D2 (tube)	Pkg unit	Part no.	Description
	M5	-	10	578404	NPQH-BK-M5-P10
	M7	-	10	578405	NPQH-BK-M7-P10
	G 1/8	-	10	578406	NPQH-BK-G18-P10
	G 1/4	-	10	578407	NPQH-BK-G14-P10
	G 3/8	-	10	578408	NPQH-BK-G38-P10
	G 1/2	-	10	578409	NPQH-BK-G12-P10

One-way flow control valve - VFOE

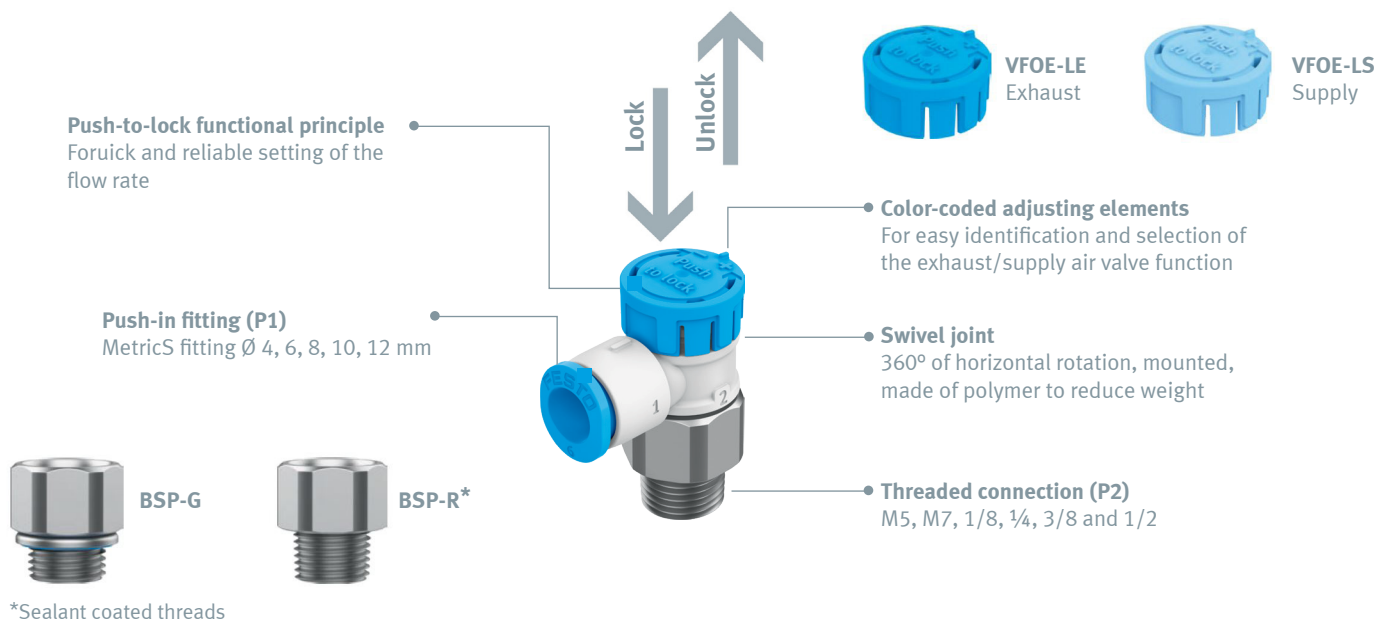

Fittings and tubing

VFOE-LE							
	Pkg. unit	P2 / P1	QS-4	QS-6	QS-8	QS-10	QS-12
Exhaust air 	1	M5	8068723	8068724			
	50	M5	8095432				
	1	G1/8	8068725	8068726	8068727		
	50	G1/8		8095433			
	1	G1/4		8068728	8068729	8068730	
	50	G1/4			8095434		
	1	G3/8			8068731	8068732	
	20	G3/8				8095435	
	1	G1/2					8068733
	20	G1/2					8095436
	1	R1/8	8068734	8068735	8068736		
	1	R1/4		8068737	8068738	8068739	
	1	R3/8			8068740	8068741	
	1	R1/2					8068742

VFOE-LS					
	Pkg. unit	P2 / P1	QS-4	QS-6	QS-8
Supply air 	1	M5	8068743	8068744	
	1	M7	8068745	8068746	
	1	G1/8	8068747	8068748	8068749
	1	R1/8	8068750	8068751	8068752



Polyurethane tubing - PUN-H

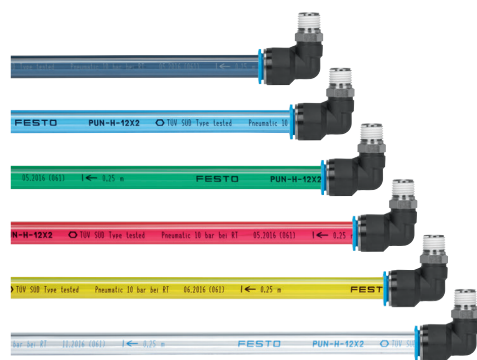

Versatile!

- Diameters 4mm...16mm OD & 1/8...5/8 inch OD
- Highly flexible tubing
- Resistant to hydrolysis and microbes
- UV-resistant
- Food-safe
- FDA-listed material
- Kink-resistant
- Solid and translucent colors
- DUO tube available in Blue & Black

PUN-H - Solid Colors								
ODD	Packed length	Packaging material	Blue	Black	Silver	Red	Green	Yellow
4 mm	50 m	Box	197383	197390	558278	558285	558292	558299
	500 m	Spool	558257	558250	558271			
6 mm	50 m	Box	197384	197391	558279	558286	558293	558300
	500 m	Spool	558258	558251	558272			
8 mm	50 m	Box	197385	197392	558280	558287	558294	558301
	400 m	Spool	558259	558252	558273			
10 mm	50 m	Box	197386	197393	558281	558288	558295	558302
	300 m	Spool	558260	558253	558274			
12 mm	50 m	Box	197387	197394	558282	558289	558296	558303
	200 m	Spool	558261	558254	558275			
14 mm	50 m	Box	570386	570387				
16 mm	50 m	Box	197388	197395	558283	558290	558297	558304
	100 m	Spool	558262	558255	558276			
1/8 in	150 ft	Box	567945	567953	567937		567977	
5/32 in	150 ft	Box	567946	567954				
	500 ft	Spool		568017				
1/4 in	150 ft	Box	567948	567956	567940	567988	567980	567972
	500 ft	Spool	568014	568018	568010			
	1000 ft	Spool	568021	568023				
5/16 in	150 ft	Box	567949	567957				
	500 ft	Spool	568022	568024	568011			
3/8 in	150 ft	Box	567950	567958	567942	567990	567982	567974
	500 ft	Spool	568016	568020				
1/2 in	150 ft	Box	567951	567959	567943	567991	567983	567975
5/8 in	150 ft	Box	567952			567992	567984	567976

NOTE: Additional materials, sizes and colors are also available. Please contact Festo.

Polyurethane tubing - PUN-H

Packaging modes:



Spool



Box

PUN-H - Translucent Colors								
OD	Packed length	Packing material	Natural (Clear)	Translucent blue	Translucent black	Translucent red	Translucent green	Translucent yellow
4 mm	50 m	Box	197376	8048671	8048673	8048675	8048677	8048679
	500 m	Spool	558264	8048672	8048674	8048676	8048678	8048680
6 mm	50 m	Box	197377	8048681	8048683	8048685	8048687	8048689
	500 m	Spool	558265	8048682	8048684	8048686	8048688	8048690
8 mm	50 m	Box	197378	8048691	8048693	8048695	8048697	8048699
	400 m	Spool	558266	8048692	8048694	8048696	8048698	8048700
10 mm	50 m	Box	197379	8048701	8048703	8048705	8048707	8048709
	300 m	Spool	558267	8048702	8048704	8048706	8048708	8048710
12 mm	50 m	Box	197380	8048711	8048713	8048715	8048717	8048719
	200 m	Spool	558268	8048712	8048714	8048716	8048718	8048720
14 mm	50 m	Box	570388					
16 mm	50 m	Box	197381					
	100 m	Spool	558269					
1/8 in	150 ft	Box	567961					
5/32 in	150 ft	Box	567962					
1/4 in	150 ft	Box	567964	8203970	8203971	8203972	8203973	8203974
	500 ft	Spool	8003126					
5/16 in	150 ft	Box	567965					
	500 ft	Spool	8003127					
3/8 in	150 ft	Box	567966	8203975	8203976	8203977	8203978	8203979
	500 ft	Spool	8003128					
1/2 in	150 ft	Box	567967	8203980	8203981	8203982	8203983	8203984

NOTE: Additional materials, sizes and colors are also available. Please contact Festo.

Please refer to the online catalog → www.festo.com/pun-h



Electric rodless actuators - ELGD / EGC

Toothed belt (TB) actuators for high speeds and long stroke lengths

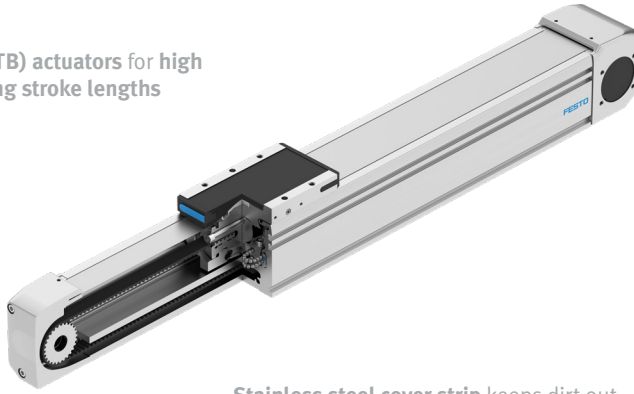

Stainless steel cover strip keeps dirt out

Ball bearing guide rails provide excellent moment handling for high loads

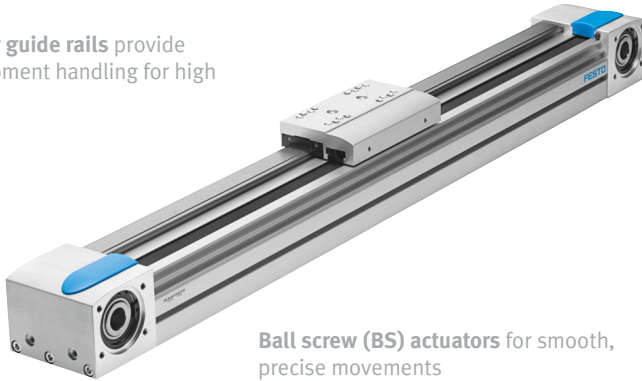

Ball screw (BS) actuators for smooth, precise movements

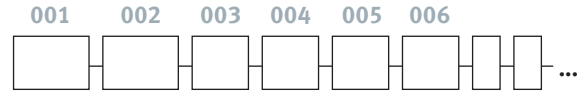

001	Series
ELGD	Rodless actuators with cover strip
EGC	Rodless actuators without cover strip
002	Drive system
TB	Toothed belt
BS	Ball screw
	Guide Type
KF	Recirculating ball bearing guide
WD	Wide ball bearing guide rails
	Size [width in mm]
---	60, 70, 80, 100, 120
	Stroke length [mm]
---	100, 200, 300, 400, 500, 600, 800, 1000, 1200, 1500, 1800, 2000
	Ball screw pitch [mm/revolution]
---	5P, 10P, 16P, 20P, 25P

Use **Electric Motion Sizing (EMS)** to select the right servo axis for your application

→ www.festo.com/EMS



Ordering – ELGD-TB

Stroke length [mm]	Size [width in mm]		
	60	80	100-WD
200	8192344	8192354	8192374
300	8192345	8192355	8192375
500	8192346	8192356	8192376
600	8192347	8192357	8192377
800	8192348	8192358	8192378
1000	8192349	8192359	8192379
1200	8192350	8192360	8192380
1500	8192351	8192361	8192381
1800	8192352	8192362	8192382
2000	8192353	8192363	8192383

Ordering – ELGD-BS

Stroke length [mm]	Ball screw pitch [mm]	Size [width in mm]					
		60		80			100-WD
		5	10	5	10	20	10
100		8192253	8192260	8192267	8192275	8192283	8192320
200		8192254	8192261	8192268	8192276	8192284	8192321
300		8192255	8192262	8192269	8192277	8192285	8192322
400		8192256	8192263	8192270	8192278	8192286	8192323
500		8192257	8192264	8192271	8192279	8192287	8192324
600		8192258	8192265	8192272	8192280	8192288	8192325
800		8192259	8192266	8192273	8192281	8192289	8192326
1000				8192274	8192282	8192290	8192327

Ordering – EGC-TB

Stroke length [mm]	Size [width in mm]		
	70	80	120
300	3012492		
400	3012493	575832	3013364
500	3012494	3013354	3013365
600	3012495	3013355	3013366
800	3012496	3013356	3013367
1000	3012497	3013357	3013368
1200	3012498	3013359	3013369
1500			3013370

Ordering – EGC-BS

Stroke length [mm]	Ball screw pitch [mm]	Size [width in mm]				
		70	80	120		
		10	10	20	10	25
100		3013388	3013532	3013539	3013571	3013578
200		3013389	3013533	3013540	3013572	3013579
300		3013390	3013534	3013541	3013573	3013580
400		3013391	3013535	3013542	3013574	3013581
500		3013392	3013536	3013543	3013575	3013582
600		3013393	3013537	3013544	3013576	3013583
800			3013538	3013545	3013577	3013584

Please refer to the online catalog → www.festo.com/ELGD



Electric cylinders - ESBF/EPCC

Electric cylinders ESBF
with feed forces up to 17 kN



High quality ball screws
for smooth motion and
long service life

Electric cylinders EPCC
with feed forces up to 1 kN



Easy assembly with Festo motors
Axial kits EAMM-A
Parallel kits EAMM-U

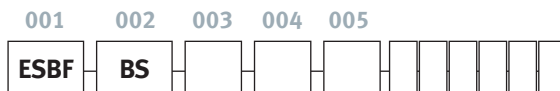
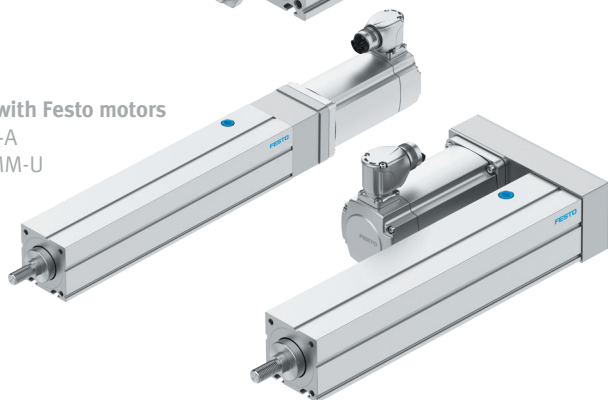

001	Series	002	Drive system
ESBF	Electric cylinder	BS	Ball screw

003	Size [mm]
---	32, 40, 50, 63

004	Stroke length [mm]
---	100, 200, 300, 400

005	Ball screw pitch [mm/revolution]
---	5P, 10P, 16P, 20P, 25P

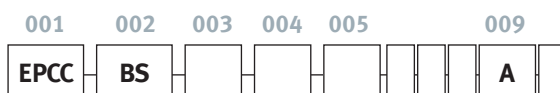

001	Series	002	Drive system
EPCC	Electric cylinder	BS	Ball screw

003	Size [mm]
---	32, 45, 60

004	Stroke length [mm]
---	25, 50, 100, 150, 200, 250, 300

005	Ball screw pitch [mm/revolution]
---	3P, 5P, 8P, 10P, 12P

Ordering – ESBF electric cylinders

Stroke length [mm]	Ball screw pitch [mm]	Size [width in mm]										
		32			40			50			63	
		5	10	5	10	16	5	10	20	5	10	25
100		8022562	8022565	8022574	8022577	8022581	8022590	8022593	8022597	574093	574096	574100
200		2215384	8022566	2215385	8022578	8022582	2215386	8022594	8022598	1347390	574097	574101
300		8022563	8022567	8022575	8022579	8022583	8022591	8022595	8022599	574094	574098	574102
400		8022564	8022568	8022576	8022580	8022584	8022592	8022596	8022600	574095	574099	574103

Ordering – EPCC electric cylinders

Stroke length [mm]	Ball screw pitch [mm]	Size [width in mm]					
		32		45		60	
		3	8	3	10	5	12
25				5428858	5428868	5428888	5428901
50		5428834	5428842	5428859	5428869	5428889	5428902
100		5428836	5428844	5428861	5428871	5428891	5428904
150		5428838	5428846	5428863	5428873	5428893	5428906
200		5428840	5428848	5428865	5428875	5428895	5428908
250						5428896	5428909
300						5428897	5428910

Use **Electric Motion Sizing (EMS)** to select the right servo axis for your application

→ www.festo.com/EMS



AC servo drives - CMMT-AS and motor - EMMT-AS

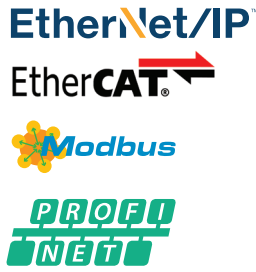

Multiprotocol fieldbus

Webserver for easy drive duplication

NEBM motor cable with robust, easy-to-use quarter-turn connector

Integrated safety: STO, SS1, SBC

EMMT-AS motor

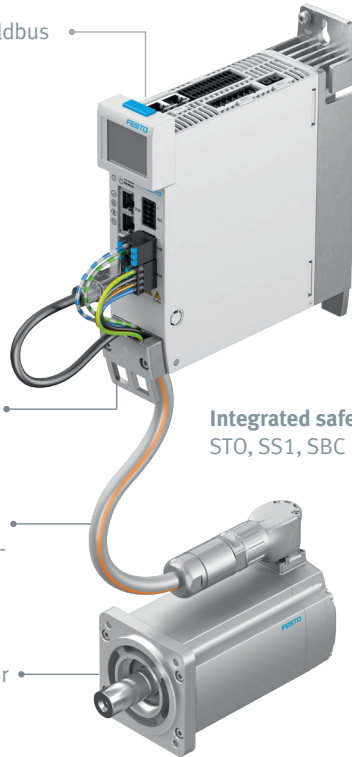

001	002	003	004	005	006	007
CMMT	AS				MP	S1

001	Type	004	Supply voltage
C2	2 A	3A	100...230 V AC
C3	3 A	11A	200...480 V AC
C4	4 A		
C5	5 A	005	Number of phases
C7	7 A		Single-phase
C12	12 A	P3	3-phase

001	002	003	004	007	008	009	010
EMMT	AS				R		

003	Flange size [mm]	007	Winding
---	60, 80, 100	LS	Low voltage, standard
		HS	High voltage, standard

004	Length	009	Encoder
S	Short	S	Absolute, single-turn
M	Medium	M	Absolute, multi-turn
L	Long		
H	Very long		

010	Brake
	No brake
B	With brake

Ordering – EMMT-AS motors

Nominal current	Nominal input voltage		Nominal current	Nominal input voltage	
	Single-phase 100...230 V AC			3-phase 200...480 V AC	
	3A-MP-S1			11A-P3-MP-S1	
2 A	8143163		2 A	8143165	
4 A	8143164		3 A	8143166	
			5 A	8143167	
			7 A	8143168	
			12 A	8143169	

Ordering – EMMT-AS motors

Motor length	Flange size									
	60				80				100	
	LS-RM	LS-RMB	HS-RM	HS-RMB	LS-RM	LS-RMB	HS-RM	HS-RMB	HS-RM	HS-RMB
Short [S]	5242197	5242199	5242201	5242203	5255426	5255428	5255430	5255432	5255521	5255529
Medium [M]	5242205	5242207	5242209	5242211	5255434	5255436	5255438	5255440	5255531	5255533
Long [L]	5242213	5242215	5242217	5242219	5255442	5255444	5255446	5255448	5255535	5255537
Very long [H]							8172104	8172026	8182016	8182014

Ordering – Accessories

Cable length	Motor Cables - NEBM	
	Q7	Q9
2.5 m	5251374	5251381
5 m	5251375	5251382
7.5 m	5251376	5251383
10 m	5251377	5251384
15 m	5251378	5251385
20 m	5251379	5251386

Motor size	Gear ratio	Gearboxes EMGA
60	3:1	2297686
	5:1	2297687
80	3:1	2297690
	5:1	2297691
100	3:1	552194
	5:1	552195

Resistance [Ω]	Nominal power [W]	Braking resistors CACR
72	150/120	1336611
100	150/120	1336615
67	720	1336617
100	720	8091545
240	120	8091543
240	720	8091544
120	50	2882342
480	40	2882343

Use **Electric Motion Sizing (EMS)** to select the right servo axis for your application

→ www.festo.com/EMS



DC servo drives - CMMT-ST and motor - EMMT-ST

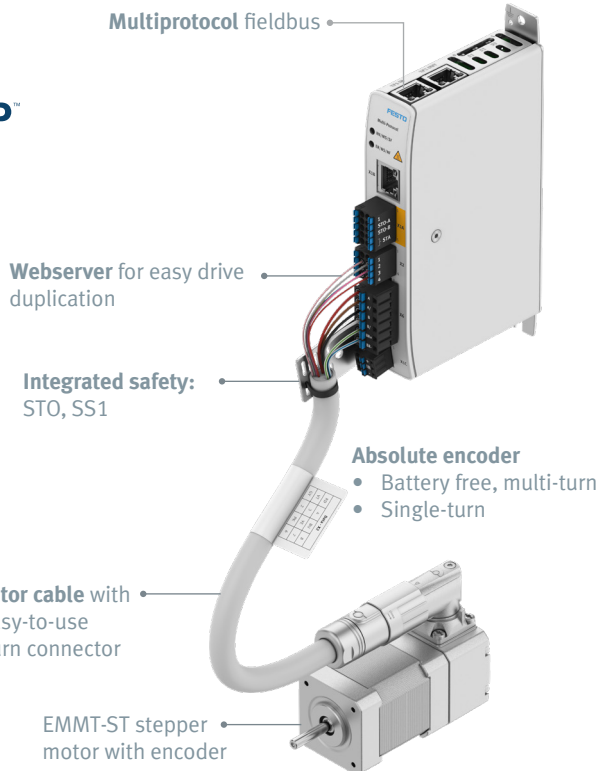

001	002	003	004	005	006
CMMT	ST	C8	1C	MP	S0

001	Type
CMMT	DC servo drive
002	Motor type
ST	Stepper motor
003	Nominal current
C8	8 A

004	Motor type
1C	24...48 V DC
005	Fieldbus
MP	Multiprotocol
006	Safety function
S0	STO/SS1

001	002	003	004	005	006	007
EMMT	ST			R		

003	Flange size [mm]
---	42, 57, 87

009	Encoder
S	Absolute, single-turn
M	Absolute, multi-turn

004	Length
S	Short
M	Medium
L	Long

010	Brake
	No brake
B	With brake

Ordering – CMMT-ST DC servo drives

Nominal current	Nominal input voltage
8 A	24...48 V DC
8 A	8163946

Ordering – EMMT-ST motors

Motor size	Encoder / brake	Motor length		
		Short [S]	Medium [M]	Long [L]
42	RS	8156162		8156168
	RM	8156163		8156169
	RSB	8156165		8156171
	RMB	8156166		8156172
57	RS		8156174	8156180
	RM		8156175	8156181
	RSB		8156177	8156183
	RMB		8156178	8156184
87	RS	8156186	8156192	8156198
	RM	8156187	8156193	8156199
	RSB	8156189	8156195	8156201
	RMB	8156190	8156196	8156202

Use **Electric Motion Sizing (EMS)** to select the right servo axis for your application

→ www.festo.com/EMS



Ordering – EMMT-ST motors

Cable length	Motor Cables - NEBM	
	Q6	Q7
2.5 m	8181670	8195458
5 m	8181668	8195459
7.5 m	8190096	8195460
10 m	8195457	8195461

Motor size	Gear ratio	Gearboxes - EMGA
42	3:1	549428
	5:1	549429
57	3:1	549430
	5:1	549431
87	3:1	549432
	5:1	549433

Resistance [Ω]	Nominal power [W]	Braking Resistors - CACR
6	60	8189339



Centralized remote I/O terminals – CPX-AP-A

Remote I/O

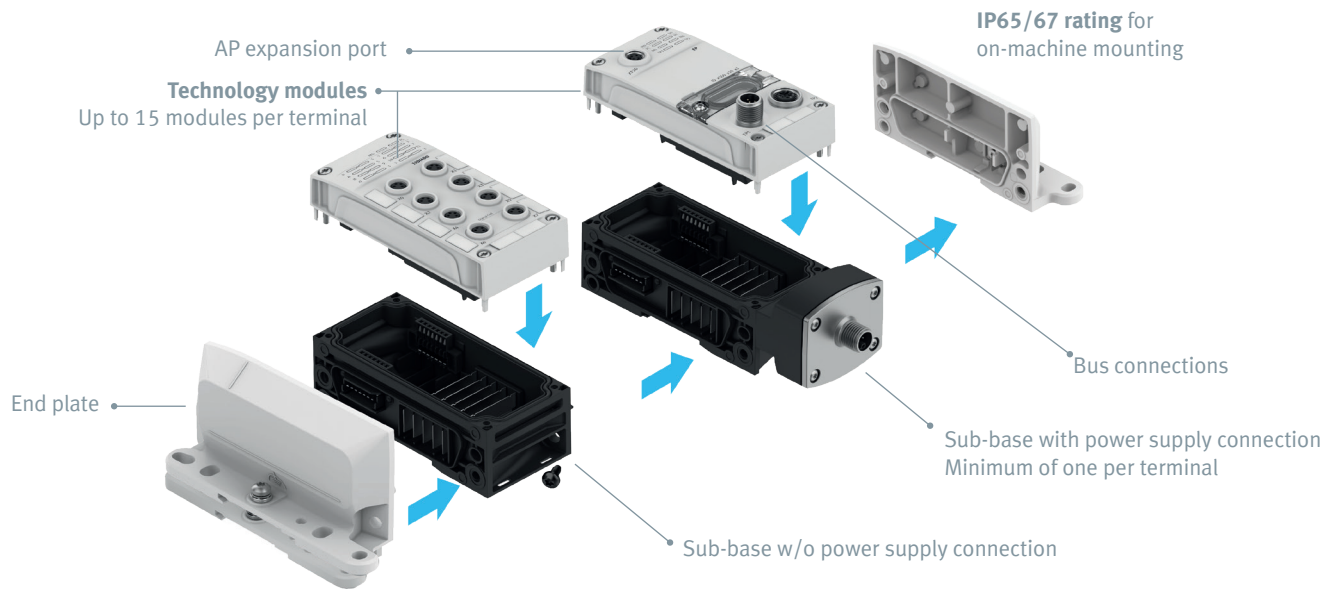

Bus interfaces

Bus protocol	Part No.
PROFINET interface	8129241
EtherCAT interface	8129243
EtherNet/IP interface (incl. Modbus TCP)	8129244

I/O modules

Module type	Connector type				
	M12	M8	Push-in (cage-clamp)	RJ45	Fiber-optic
8 digital inputs	8129109	8129103	8129106	-	-
16 digital inputs	8129112	-	-	-	-
12 digital inputs, 4 digital outputs	8129111	8129105	8129108	-	-
8 digital outputs	8129110	8129104	8129107	-	-
8 digital outputs, high current	8175409	-	-	-	-
4 analog inputs	8129113	-	-	-	-
IO-Link master, 4 Type B ports	8129114	-	-	-	-

Sub-bases

Module type	Connector type				
	M18	7/8" (5-pin)	M12 (5-pin)	AIDA Push-pull	-
No supply	-	-	-	-	8129251
System supply	8129254	8129255	8129256	8129253	-
System supply with forwarding	-	-	8129261	-	-
Forwarding only	-	-	-	8169617	-
Power zone to the right	8129258	8129259	8129260	8129257	-
Power zone to the left	-	-	8129263	8129262	-

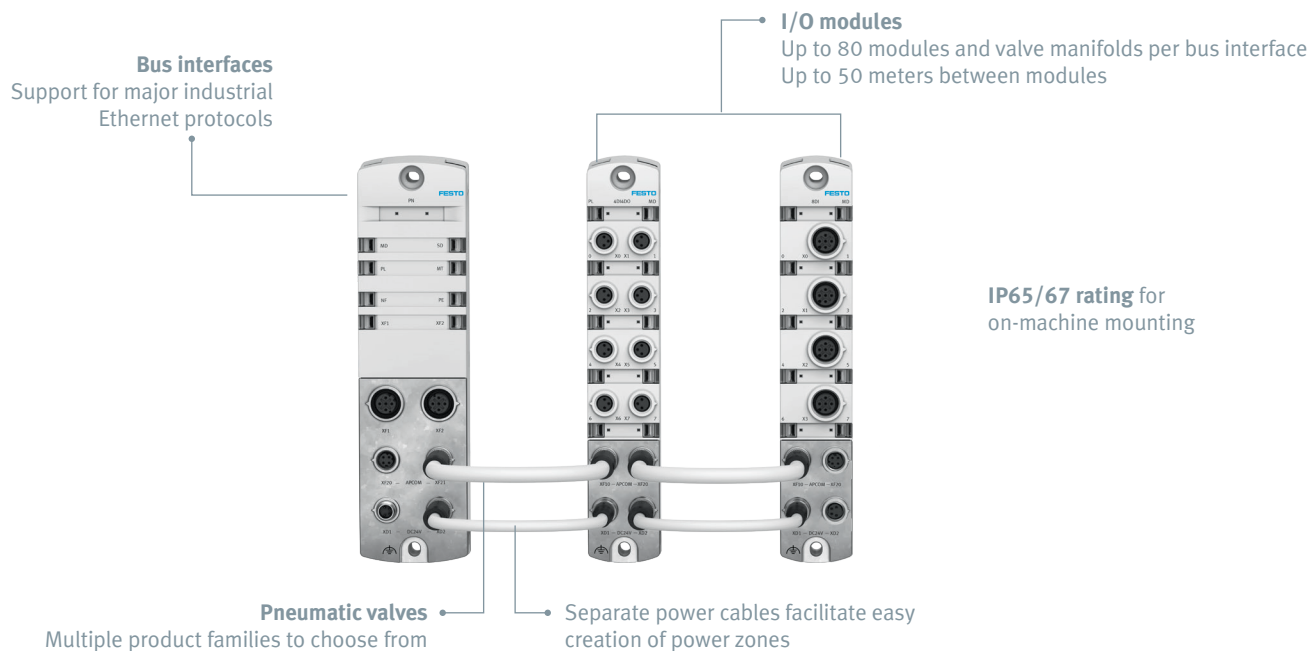

Decentralized remote I/O modules – CPX-AP-I

**Bus interfaces**

Bus protocol	Part No.
PROFINET	8086607
EtherCAT	8086609
EtherNet/IP (incl. Modbus TCP)	8086610

I/O modules

Module type	M8 connector, 3 pin	M12 connector, 5 pin
4 digital inputs	8086605	-
8 digital inputs	8086600	8086602
8 digital outputs	8179438	8179439
4 digital inputs, 4 digital outputs	8086601	8086603
4 analog inputs	-	8086606
IO-Link master, 4 Type B ports	-	8086604



In-cabinet remote I/O and controllers – CPX-E

Remote I/O

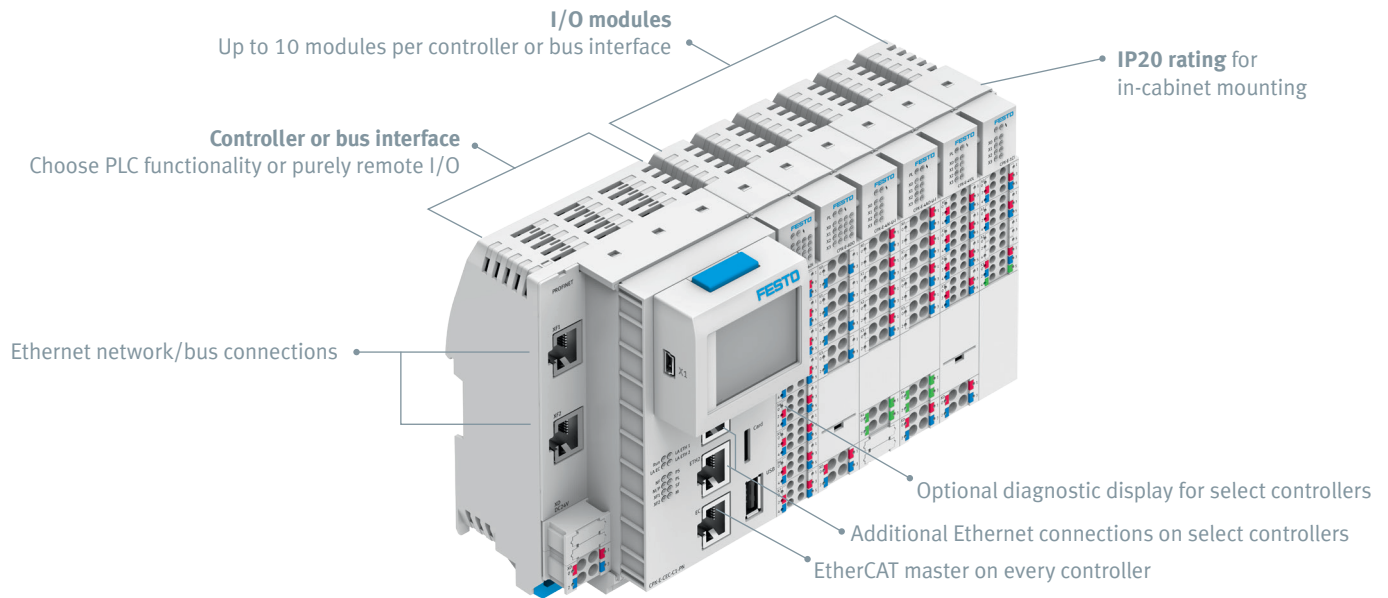

Controllers

For applications requiring PLC and/or motion control functionality

Software version	Bus interface		
	-	PROFINET	EtherNet/IP (incl. Modbus TCP)
CODESYS V3	5226780	4252741	4252742
CODESYS V3 w/ SoftMotion	5266781	4252743	4252744

Bus interfaces

For applications requiring only remote I/O

PROFINET	EtherCAT	EtherNet/IP (incl. Modbus TCP)
4080497	4080498	4080499

I/O modules

Up to 10 modules per controller or bus interface

Type	Part No.
16 digital inputs	4080492
8 digital outputs	4080491
1 digital counter/encoder input	4827505
4 analog inputs	4080493
4 analog outputs	4080494
IO-Link master, 4 ports	4080495



Notes

A series of horizontal dashed lines for writing notes.

Your partner in automation



1 Festo Canada

5300 Explorer Drive
Mississauga, ON L4W 5G4
Canada

Contact Center

Tel: 1 877 463 3786
Fax: 1 877 393 3786
Email: customer.service.ca@festo.com

2 Festo Mexico

Av. Ceylan 3,
Col. Tequesquihuac
54020 Tlalnepantla,
Estado de Mexico

Contact Center

01 800 337 8669
ventas.mexico@festo.com

3 Festo US

1377 Motor Parkway
Suite 310
Islandia, NY 11749
USA

Contact Center

1 800 993 3786
1 800 963 3786
customer.service.us@festo.com

4 Festo Regional Service Center

7777 Columbia Road
Mason, OH 45039
USA

In stock and ready to ship.

Learn more about Festo FASTSM:

